

Messrs.

DATE

09, SEP, 2021

Rev No.

1.1

# APPROVAL SHEET

Description	Full-HD Zoom Camera Series
Model Name	DTC-Z7830H-LA/LT

Receipt stamp

--

Issued	Checked	Approved



DynaLogic Co., Ltd

# Revision History

Date	Rev. No	Contents
2021.09.09	1.0	Release Document

# TABLE OF CONTENTS

TABLE OF CONTENTS	-----	3
FEATURES	-----	4
PRECAUTION	-----	5
SPECIFICATIONS	-----	6
OSD & MENU	-----	9
DIMENSION	-----	16
INTERFACE	-----	17
FUNCTIONS	-----	22
COMMAND LIST	-----	28

# FEATURES

*This Product is a high performance CCTV camera with built-in 30x optical zoom and 12x digital zoom technologies. This product can be applied to various fields such as security camera for surveillance (CCTV camera), data viewer, Video presenter(VP) and speed dome camera*

- This camera uses a 1/2.8" 2.13M Exmor R CMOS Image Sensor that supports FULL HD (high definition) to produce high-quality images.
- Using progressive scan, images with a wide dynamic range can be obtained with the newly developed image signal processor (Wide Dynamic Range function, WDR).
- The camera is equipped with a bright zoom lens with 30× optical zoom and F1.6 aperture (optical zoom + digital zoom = 360×)
- Low-noise images can be obtained even in low-light environments using the Noise Reduction function(3DNR/2DNR)
- Video signals can be output as digital only. Depending on register settings, you can select from a variety of digital output methods:  
1080p/60,1080p/50,1080p/30, 1080p/25,  
720p/60,720p/50,720p/30, 720p/25, 1080i/60,  
1080i/50
- An infrared (IR) Cut-Filter can be disengaged from the image path for increased sensitivity in low light environments. The ICR will automatically engage depending on the ambient light, allowing the camera to be effective in day/night environment.
- A Privacy Zone Masking function (max. 16 blocks) is available.

- A Motion Detection function is available.
- A title composed of up to 21 lines can be set for displaying on the screen. 30 characters can be used on one line (VISCA).
- Support 256 internal zoom/focus presets.
- Digital Image Stabilizer function reduces image blurring caused by vibration.
- Output format  
HD-SDI/EX-SDI(V1.0)/LVDS/CVBS/AHD/TVI
- LVDS output mode can be set.  
Single / Dual output



**DTC-Z7830H**  
1/2.8" Sensor

# PRECUTION

## *Operation is subject to the following conditions;*

- This device may not cause harmful interference.
- This device must accept any interference received, including interference that may cause undesired operation.
- A regulated DC 12V 500mA power supply is recommended for use with this camera for the best image and the most stable operation. An unregulated power supply can cause damage to the camera. When unregulated power supply is applied, product warranty will be out of subject.
- If it is used for CVBS application. It is recommended that the camera is used with a monitor that has a CCTV quality 75 Ohm video impedance level. If your monitor is switched to high impedance then please adjust accordingly.
- Do not attempt to disassemble the camera to gain access to the internal components. Refer servicing to your dealer.
- Never face the camera towards the sun or any bright or reflective light, which may cause smear on the image and possible damage to the CMOS.
- Do not remove the serial sticker for the warranty service.
- Do not drop the thing or give a strong impact to the product.
- Avoid the place where is so dusty, humid or soot-covered. It may cause electric shock or fire.
- Do not expose to an intense light source such as direct sunlight or spotlight. It may damage the CMOS.
- If the camera operates more than 24 hours, It is recommended that you execute the lens initial action or reset the camera.
- **Since the color representation differs depending on the DVR, you have to select the type of DVR to use in the menu.**
- **When outputting video with CVBS, DVR selection must be set to CVBS. When outputting images using AHD / TVI DVR, you must select the appropriate DVR.**

## *Information may be changed without notice*

*This document provides technical information for the user. Dynalogic reserves the right to modify the information in this document as necessary. The customer should make sure that they have the most recent manual version.*

# SPECIFICATION

Format	DTC-Z7830H-LA	DTC-Z7830H-LT
<b>Video System</b>		
<b>Image Sensor</b>	1/2.8" Exmor R CMOS (STARVIS)	
<b>Effective Pixels</b>	2.13 million pixels (1945(H) x 1097(V))	
<b>Output Format</b>	LVDS/HD-SDI/CVBS : 1080p60/50/30/25, 720p60/50/30/25, 1080i60/50	
	EX-SDI: 1080p30/25, 720p60/50/30/25	AHD : 1080p30/25
<b>Sync System</b>	Internal	
<b>CVBS scale</b>	16:9 / 4:3 (CVBS 720H)	
<b>LVDS mode</b>	Single / Dual	
<b>Video Output</b>	HD-SDI / EX-SDI(V1.0) / CVBS / LVDS	
	HD-AHD	HD-TVI
<b>Min. illumination</b>	<i>(condition : DSS OFF, AGC28dB)</i>	
<b>Day</b>	0.1 Lux @ F1.6	
<b>Night (IR-cut filter on)</b>	0.06 Lux @ F1.6	
<b>S/N ratio(AGC off , DSS off)</b>	More than 52 dB	
<b>Optical Lens</b>		
<b>Zoom Magnification</b>	X30	
<b>Practical f-value</b>	5.0 to 150.0 mm	
<b>Practical Horizontal-Angle</b>	59.2°(W) ~ 2.0°(T)	
<b>Practical Vertical Angle</b>	33.8°(W) ~ 1.15°(T)	
<b>Practical Diagonal Angle</b>	67.5°(W) ~ 2.46°(T)	
<b>F-value</b>	F1.6(W) ~ F4.3(T)	
<b>Zoom</b>		
<b>Maximum Zoom Ratio</b>	x1 ~ x360	
<b>Optical Zoom Ratio</b>	x1 ~ x30	
<b>Digital Zoom Ratio</b>	x1 ~ x12	
<b>Speed (Focus Tracking On)</b>	4.6 ~ 40 sec	
<b>(Focus Tracking Off)</b>	3.6 sec	
<b>Focus</b>		
<b>Control Mode</b>	Auto / Manual / Interval / One Shot(=Zoom Trigger, One Push)/PRESET	
<b>IR correction</b>	Standard/IR Light	
<b>Focal Range</b>	Infinity~1.5m(T)/0.1m(W)	
<b>Day &amp; Night</b>		
<b>D&amp;N mode</b>	Auto / Day (Color) / Night (BW) / External-H / External-L	
<b>Night Color</b>	Off/On	
<b>White Balance</b>	Auto / ATW / Indoor / Outdoor / Push / Manual	
<b>Exposure</b>		
<b>AE mode</b>	Auto / Shutter Priority / Iris Priority/ Manual/Bright	
<b>Brightness</b>	0~14	
<b>AGC Limit</b>	-3dB ~ 58dB	
<b>Manual Shutter</b>	1/1, 1/2, 1/4(3), 1/8(6), 1/15(12),1/30(25), 1/60(50)~1/30000	
<b>Manual AGC</b>	-3dB ~ 58dB	
<b>Manual Iris</b>	F1.6 ~ F19, Close	
<b>Sens-Up</b>	Off ~ 32fields	
<b>ETC</b>	Spot AE, Slow AE response	

Format	DTC-Z7830H-LA	DTC-Z7830H-LT
OSD	English / Japanese / Russian / Spanish / German /France/ Portuguese / Chinese	
<b>DSP functions</b>		
<b>Digital Slow Shutter</b>	Max. 32 fields	
<b>Image Freeze</b>	Off / On	
<b>Image Reverse (E-FLIP)</b>	Off / Horizontal(mirror) / Vertical / H+V(180° flip)	
<b>Privacy Masking</b>	Spherical Privacy - 16-zone - Interlock / Non-Interlock Mask - 14 mask color selectable, semi-transparency - Pan(0°~360°), Tilt(+90°~-90°)	
<b>Title Display</b>	16 characters (display position selectable)	
<b>Motion Detect</b>	4-Zone - Alarm output : OSD / Serial Communication	
<b>D-WDR</b>	Off / Low/Middle/High	
<b>WDR</b> <small>(NOTE1)</small>	WDR (Low/Middle/High)	
<b>BLC</b>	Off / On, Area selectable	
<b>HLC</b>	Off / 0 ~ 20, Color selectable	
<b>AGC</b>	Max. 58dB	
<b>Sharpness</b>	Adjustable(0~15)	
<b>3DNR</b>	Off/On(1~5)	
<b>2DNR</b>	Auto/Manual(Weight High/Low)	
<b>Defog</b>	Off / Low / Middle / High	
<b>Gamma</b>	0.45/0.50/0.55/0.60/0.65/0.70/0.75	
<b>Lens Shading</b>	Off / Low / Middle / High	
<b>Defect Detection</b>	Support	
<b>Digital Image Stabilizer</b>	On / Off	
<b>Picture Effect</b>	Negative/Positive, Blanck&White(Monochrome Image)	
<b>Position Preset (zoom/focus)</b>	Non-volatile 256 position(zoom/focus) presets.	
<b>Memory Preset</b>	16-presets & custom preset	
<b>HD-SDI UCC</b>	DTC-HZ78xxxxU model only	
<b>HD- UTC</b>	AHD UTC	TVI UTC (PelcoC/HikvisionC)
<b>Communication (UART)</b>		
<b>Camera ID</b>	0~255	
<b>Remote Control</b>	RS-232 TTL +5.0V (+3.3V Compatible) / RS485	
<b>Control Protocol</b>	VISCA /Pelco-D/Pelco-P/HITACHI : automatically detection	
<b>Communication Speed</b>	2400/4800/9600(default)/19200/38400/57600/115200bps selectable	
<b>Power</b>		
<b>Supply Voltage</b>	DC 12V (+7.0V ~ +15V)	
<b>Supplied Current(motor on)</b>	260mA(430mA)	
<b>Consumption (motor on)</b>	3.2W(5.2W)	
<b>Physical</b>		
<b>Dimension (WxHxD) [mm]</b>	50.0x58.8x96.1	
<b>Weight</b>	260g	
<b>Temperature&amp; Humidity</b>		
<b>Operating condition</b>	Temperature (-10°C~50 °C / 14°F~122°F), Humidity (20% ~ 80%)	
<b>Storage condition</b>	Temperature (-20°C~60 °C / -4°F~140°F), Humidity (20% ~ 95%)	

(NOTE1) When CVBS is connected, WDR automatically turns off and Digital WDR operates.

## INTERFACE SUMMARY

Interface & Video		DTC-Z7830H-LA	DTC-Z7830H-LT
Video Output	EX-SDI (V1.0)	○	○
	HD-SDI	○	○
	HD-TVI	-	○
	HD-AHD	○	-
	CVBS	○	○
	LVDS	◎	◎
Interface	30pin Micro Coaxial (USL00-30L-C, 0.4mm)	◎	◎
	24pin FFC (SFV24R-1STE1HLF, 0.55mm)	-	-
	9pin FFC (52207-0985, 1.0mm)	○	○
	3pin External D&N (SM03B-SRSS-TB, 1.0mm)	○	○
	4pin AHD/TVI (53261-0471, 1.25mm)	○	○
	2pin RS-485 (53261-0271, 1.25mm)	○	○
	MMCX	○	○

◎ : Main Video Output / Main Control Connector

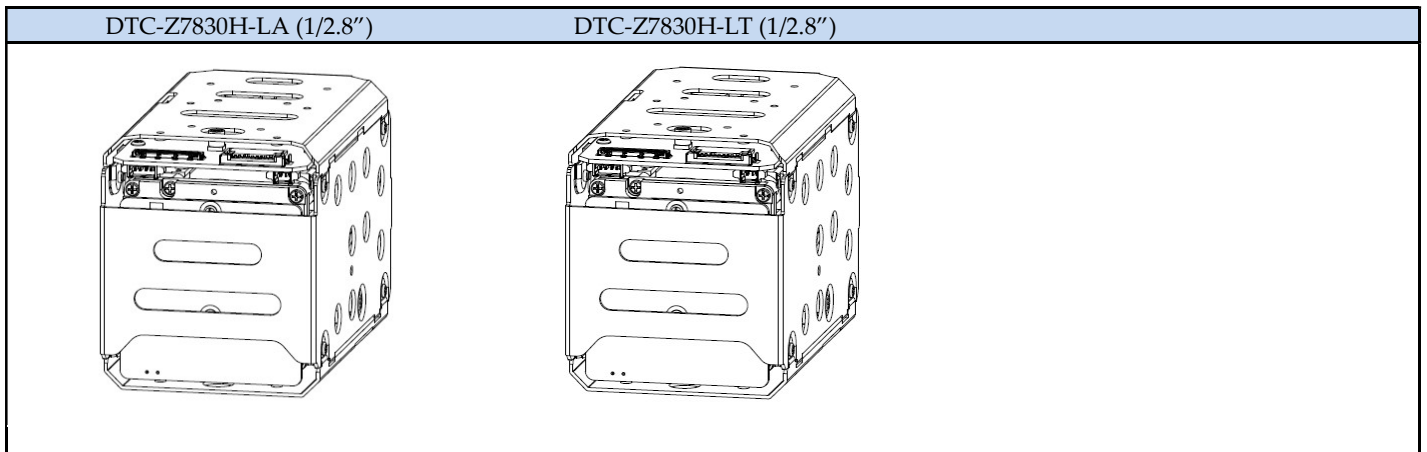



# OSD & MENU

## MAIN MENU

<b>FOCUS</b>	[←]
<b>EXPOSURE</b>	[←]
<b>WHITE BALANCE</b>	[←]
<b>WDR/BLC</b>	[←]
<b>DAY&amp;NIGHT</b>	[←]
<b>IMAGE</b>	[←]
<b>SPECIAL</b>	[←]
<b>FACTORY DEF</b>	OK
<b>EXIT</b>	

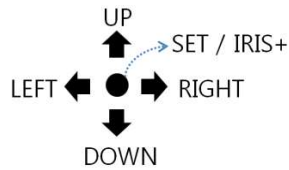

UP/DOWN : move cursor  
 LEFT/RIGHT : change data, enter to submenu  
 SET (or IRIS OPEN) : used for SET key

- ▶ **FACTORY DEF** : factory default setting  
 It changes the entire menu in the initial state except "SYSTEM" menu items.

## SIZE & POSITION

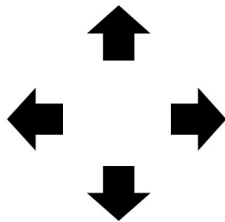

**RETURN : [SET] KEY**

- Adjust SIZE or POSITION.
- CAM TITLE POSITION MENU
  - CAM ID POSITION MENU
  - ZOOM MAG POSITION MENU
  - PRIVACY MASK PAN/TILT POSITION MENU
  - PRIVACY MASK SIZE MENU
  - FOCUS PRESET POSITION SETTING MENU

## FOCUS

<b>AF MODE</b>	<b>AUTO</b>
<b>D-ZOOM</b>	<b>ON</b>
<b>ZOOM START</b>	<b>x1</b>
<b>ZOOM STOP</b>	<b>x360</b>
<b>ZOOM SPEED</b>	<b>6</b>
<b>FOCUS LIMIT</b>	<b>1M</b>
<b>AF INTERVAL</b>	<b>1min</b>
<b>HOME POSITION</b>	<b>OFF</b>
<b>PRESET POSITION</b>	[←]
<b>PRESET MARGIN</b>	<b>10</b>
<b>INITIAL</b>	<b>OK</b>
<b>RETURN</b>	

Setting Zoom/Focus function

- ▶ **AF MODE** : AUTO/ONE SHOT/INTERVAL/MAMUAL/PRESET
  - ▶ **DIGITAL ZOOM** : OFF/ON
  - ▶ **ZOOM START/STOP**
  - ▶ **ZOOM SPEED** : 0~7
  - ▶ **FOCUS LIMIT** : 10CM~INF, focus near limit.
  - ▶ **AF INTERVAL** :1min~10min  
 Auto Focus interval when AF INTERVAL mode
  - ▶ **HOME POSITION** : OFF/ON  
 Go to X1 position when power on.
  - ▶ **PRESET POSITION** : Select target position for PRESET AF
  - ▶ **PRESET** : Select PRESET auto focusing range, 4~255
- (\*)See. "FUNCTIONS"

## EXPOSURE

**AE MODE** AUTO  
**FLICKERLESS** OFF  
**IRIS** F4.8  
**SHUTTER** 1/30  
**AGC** 32dB  
**AGC MAX** 32dB  
**SENS UP** X32  
**BRIGHTNESS** 8  
**INITIAL** OK  
**RETURN**

Setting Auto Exposure function.

▶ AE MODE : AUTO/IRIS.P//SHUT.P//MANUAL

MODE	AUTO	IRIS.P	SHUT.P	MANUAL
FLICKERLESS	O	X	X	X
IRIS	X	O	X	O
SHUTTER	X	X	O	O
AGC	X	X	X	O
AGC MAX	O	O	O	X
SENS UP	O	O	O	O
WDR	O	X	X	X

▶ IRIS : F1.2~CLOSE, Select Manual Iris Value

▶ SHUTTER : X32~X2,1/30,~,1/30000, Manual Shutter Speed

▶ AGC : -3dB~58dB, Manual Gain Value

▶ AGC MAX : -3dB ~ 58dB, AGC maximum rate

▶ SENS UP : OFF,X2,X4,X8,X16,X32, Slow Shutter value

▶ BRIGHTNESS : 1~14, Image Brightness

## WHITE BALANCE

**WB MODE** AUTO  
**PUSH AUTO** [ ]  
**COLOR GAIN** 5  
**RED GAIN** 10  
**BLUE GAIN** 10  
**INITIAL** OK  
**RETURN**

Setting Auto White Balance Function.

▶ WB MODE :

AUTO/INDOOR/OUTDOOR/ATW/ONE PUSH/MANUAL

AUTO : Automatically adjusts color

INDOOR / OUTDOOR : Set color temperature to be indoor/outdoor light

ATW : Auto Trace White balance

ONE-PUSH : fix the color if pressed PUSH button

MANUAL : Adjust color manually.

▶ PUSH AUTO : if WB mode is ONE PUSH

▶ COLOR GAIN : 0~20, adjust Chroma gain

▶ RED/BLUE GAIN : 0~255, adjust manual Red/Blue gain

## WDR/BLC

**MODE** BLC  
**LEVEL** 5  
**BLC X-POSITION** 7  
**BLC Y-POSITION** 6  
**BLC X-SIZE** 4  
**BLC Y-SIZE** 5  
**COLOR** BLACK  
**INITIAL** OK  
**RETURN**

Setting WDR/BLC/HLC function

▶ WDR/BLC MODE : OFF/BLC/HLC/WDR

BLC : Backlight Compensation mode

HLC : Highlight Compensation mode

WDR : Wide Dynamic Range mode

▶ LEVEL : adjust HLC/WDR Level

HLC : 0~20

WDR : LOW/MIDDLE/HIGH

▶ BLC X- POSITION : adjust BLC X-window position

▶ BLC Y- POSITION : adjust BLC Y-window position

▶ BLC X-SIZE : adjust BLC X-window size

▶ BLC Y-SIZE : adjust BLC Y-window size

▶ HLC COLOR : BLACK/WHITE/YELLOW/CYAN/GREEN/MAGENTA/  
RED/BLUE

◆ (Caution !!!)

WDR is available if AE MODE is AUTO.

## DAY&NIGHT

<b>MODE</b>	<b>AUTO</b>
<b>DWELL TIME</b>	<b>5sec</b>
<b>DAY-&gt;NIGHT</b>	<b>28</b>
<b>NIGHT-&gt;DAY</b>	<b>4</b>
<b>IR SMART</b>	<b>0</b>
<b>INITIAL RETURN</b>	<b>OK</b>

### Setting Day&Night Function

- ▶ **MODE** : AUTO/DAY/NIGHT/EXT-H/EXT-L
- ▶ **DWELL TIME** : 0~20sec
- ▶ **DAY->NIGHT** : 1~28
- ▶ **NIGHT->DAY** : 0~27
- ▶ **NIGHT COLOR** : BW/COLOR  
Select color at night condition.
- ▶ **IR SMART** : 0~20

## IMAGE

<b>SHARPNESS</b>	<b>8</b>
<b>GAMMA</b>	<b>0.50</b>
<b>MIRROR</b>	<b>OFF</b>
<b>FREEZE</b>	<b>OFF</b>
<b>D-WDR</b>	<b>OFF</b>
<b>DEFOG</b>	<b>[↔]</b>
<b>DNR</b>	<b>[↔]</b>
<b>DIS</b>	<b>[↔]</b>
<b>EFFECT</b>	<b>[↔]</b>
<b>INITIAL RETURN</b>	<b>OK</b>

### Setting Image Function

- ▶ **SHARPNESS** : 0~15
- ▶ **GAMMA** : 0.45/0.50/0.55/0.60/0.65/0.70/0.75
- ▶ **MIRROR** : OFF/H-MIR/V-MIR/HV-MIR
- ▶ **FREEZE** : OFF/ON
- ▶ **D-WDR** : OFF/LOW/MIDDLE/HIGH
- ▶ **Defog** : Setting Defog
- ▶ **DNR** : Setting Digital Noise Reduction
- ▶ **DIS** : Setting Digital Image Stabilization
- ▶ **EFFECT** : Setting Digital Effects

## DEFOG

<b>MODE ON/OFF</b>	<b>ON</b>
<b>MODE</b>	<b>AUTO</b>
<b>LEVEL</b>	<b>MIDDLE</b>
<b>RETURN</b>	

### Setting Defog

- ▶ **MODE ON/OFF** : OFF/ON
- ▶ **MODE** : AUTO/MANUAL
- ▶ **LEVEL** : LOW/MIDDLE/HIGH

## DNR

**3DNR** 1  
**2DNR MODE** AUTO  
**2DNR WEIGHT-H** 250  
**2DNR WEIGHT-L** 0  
**RETURN**

### Setting Digital Noise Reduction

- ▶ 3DNR : OFF/1~5, 3DNR weight
- ▶ 2DNR MODE : AUTO/MANUAL
- ▶ 2DNR WEIGHT-H : 2DNR MANUAL High frequency weight
- ▶ 2DNR WEIGHT-L : 2DNR MANUAL Low frequency weight

#### 2DNR Weight

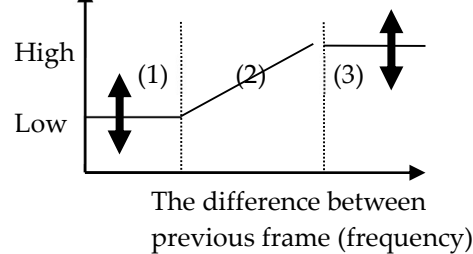

- (1) Low frequency area
- (2) Excluded area when 2DNR manual mode
- (3) High frequency area

## DIS

**MODE** OFF  
**RANGE** 30%  
**FILTER** MIDDLE  
**AUTO C** HALF  
**RETURN**

### Setting Digital image stabilization

- ▶ MODE : OFF/ON
- ▶ RANGE : 10%/20%/30%
- ▶ FILTER : LOW/MIDDLE/HIGH
- ▶ AUTO C : OFF/HALF/FULL

## EFFECT

**PIC.EFFECT** OFF  
**HR MODE** OFF  
**RETURN**

### Setting Digital Effect function

- ▶ PIC.EFFECT : OFF/NEGATIVE/BW
- ▶ HR MODE : OFF/ON  
High Resolution mode

## SPECIAL

CAM TITLE	[↵]
DISPLAY	[↵]
PRIVACY	[↵]
MOTION	[↵]
SYSTEM	[↵]
INITIAL	OK
RETURN	

### Setting Special Functions

- ▶ CAM TITLE : edit camera title
- ▶ DISPLAY : select display mode
- ▶ PRIVACY : adjust privacy mask status
- ▶ MOTION : adjust motion detect function
- ▶ SYSTEM : system setting
- ▶ INITIAL : (!!!) SYSTEM menu is NOT initialized.

## CAM TITLE

↓  
TITLE: \_\_\_\_\_  
ABCDEFGHIJKLMNPO  
QRSTUVWXYZ! - ( ) [ ]  
0123456789? \* : " / .  
SPA>>            <<BAK

DISPLAY	OFF
LOCATION	↵
RETURN	

### Setting Camera Title

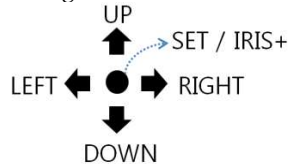

[ Title Edit ]

UP/DOWN : move cursor up&down  
LEFT/RIGHT : move cursor left&right  
SET (or IRIS OPEN) : select cursor character.

- ▶ DISPLAY : OFF/ON, enable/disable title display
- ▶ LOCATION : adjust TITLE display position

## DISPLAY

CAM ID DISP	ON
CAM ID POS	↵
ZOOM MAG DISP	ON
ZOOM MAG POS	↵
INITIAL	OK
RETURN	

### Setting On Screen Display

- ▶ CAM ID DISP : OFF/ON, Camera ID display mode
- ▶ CAM ID POS : Camera ID display position setting
- ▶ ZOOM MAG DISP : OFF/ON
- ▶ ZOOM MAG POS : Zoom ration display position setting

## PRIVACY

MODE	ON
ZONE NO	1
DISPLAY	ON
P/T LOCK	ON
POSITION	ON
ZONE SIZE	[←]
COLOR	BLACK
TRANSPARENCY	25%
ZONE RESET	[←]
INITIAL	OK
RETURN	

### Setting Spherical Privacy mask

- ▶ MODE : OFF/ON, Privacy mask enable/disable
- ▶ ZONE NO : 1~24, Privacy mask zone number
- ▶ ZONE DISPLAY : OFF/ON, current mask zone display on/off.
- ▶ P/T INTERLOCK : interlocking Pan&Tilt.
- ▶ POS.ZOOM : select zoom position.  
[LEFT] zoom out, [RIGHT] zoom in
- ▶ POS.PAN/TILT : select pan/tilt position.(if P/T INTERLOCK OFF)
- ▶ ZONE SIZE : select mask zone width&height.
- ▶ COLOR : select mask zone color, BLACK,GRAY1~6,WHITE,RED, GREEN,BLUE,CYAN,YELLOW,MAGENTA
- ▶ TRANSPARENCY : select transparent level. OFF/25%/50%/75%
- ▶ ZONE RESET : reset the mask size, zoom, pan, tilt position.

## MOTION

MODE	ON
ZONE NO	1
ZONE DETECT	ON
X-POSITION	1
Y-POSITION	1
X-SIZE	58
Y-SIZE	32
SENSITIVITY	MIDDLE
ALARM MODE	TEXT
INITIAL	OK
RETURN	

### Setting Motion Detect

- ▶ MODE : OFF/ON, Enable/disable the Motion Detection.
- ▶ ZONE NO : 1~4, select the motion detection window.
- ▶ ZONE DETECT : OFF/ON, select the detection mode of current zone.
- ▶ X-POSITION : adjust motion detect zone X-position.
- ▶ Y-POSITION : adjust motion detect zone Y-position.
- ▶ X-SIZE : adjust motion detect zone X-size.
- ▶ Y-SIZE : adjust motion detect zone Y-size.
- ▶ SENSITIVITY : 0~10, select the motion detect sensitivity level.
- ▶ ALARM MODE: OFF/OSD/TEXT/OSD+TEXT, select the display method if motion is detected.

## SYSTEM

LANGUAGE	ENGLISH
FRAMERATE	1080_60p
DVR	STANDARD
APPLY	[↵]
CVBS	16:9
LVDS MODE	SINGLE
IR LED	NO
DEFECT DET	[←]
COLOR	[←]
COM	[←]
RETURN	

### Setting System Function

- ▶ LANGUAGE : English / Japanese / Russian / Spanish / German /France/ Portuguese/ Chinese
- ▶ FRAMERATE : 1080\_60p/1080\_50p/1080\_30p/1080\_25p/720\_60p/720\_50p/720\_30p/720\_25p/1080\_60i/1080\_50i
- ▶ DVR : Select DVR model. (\*) See. "Supported DVRs"
- ▶ APPLY : apply the <FRAMERATE>,<DVR> settings.

*Two messages are output when APPLY is executed.  
The first message is a message that is output before the status is changed, and the second message is a message that is output after the status is changed.  
If the status is changed, the image may not be output. In this case, if you wait 20 seconds without any keystroke, it will be restored to its original state.*

- ▶ CVBS : 16:9 / 4:3, select CVBS scale
- ▶ LVDS MODE : SINGLE/DUAL(=double)
- ▶ IR LED : YES(use IR LED at night) /NO
- ▶ DEFECT DET : defect detection
- ▶ COLOR : Adjust R/B gain, R/B hue
- ▶ COM : RS232 / RS485 communication Setting.

**(!!!) All of the SYSTEM menu items are NOT initialized.**

## COLOR

```

BY_GAIN-           80
BY_GAIN+           58
RY_GAIN-           68
RY_GAIN+           44
BY_HUE-            224
BY_HUE+            232
RY_HUE-            0
RY_HUE+            128
RED GAIN            60
GREEN GAIN          50
BLUE GAIN           60
RESET              ←i
RETURN
    
```

## Adjust Color Gain

► BY-GAIN ~ RY\_HUE, R/G/B-GAIN : adjust color

GAIN : Chroma (saturation) value

HUE : Hue

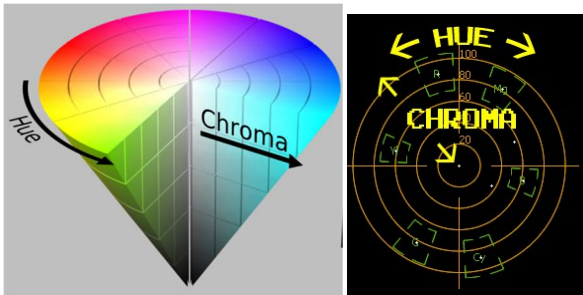

(!!!) These values are NOT initialized.

## <CbCr Plane>

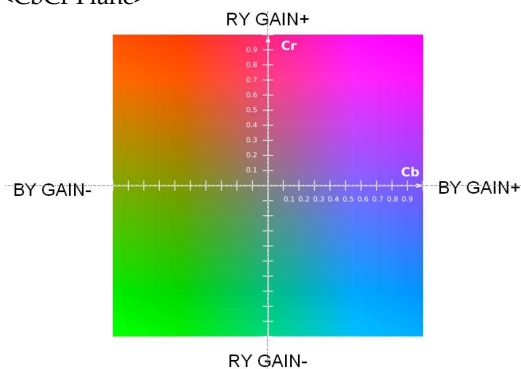

(f.g) If you want to emphasize the GREEN color, adjust BY-GAIN- and RY-GAIN-.

## COM

```

CAM ID             1
BAUDRATE           9600
APPLY              ←i
RETURN
    
```

## Setting Serial Interface

► CAM ID : 0~255

► BAUDRATE: 2400/4800/9600/19200/38400/57800/115200 bps

► APPLY : apply the <CAM ID>,<BAUDRATE> condition.

# DIMENSION

## Zoom module (DTC-Z7830H-LA/LT)

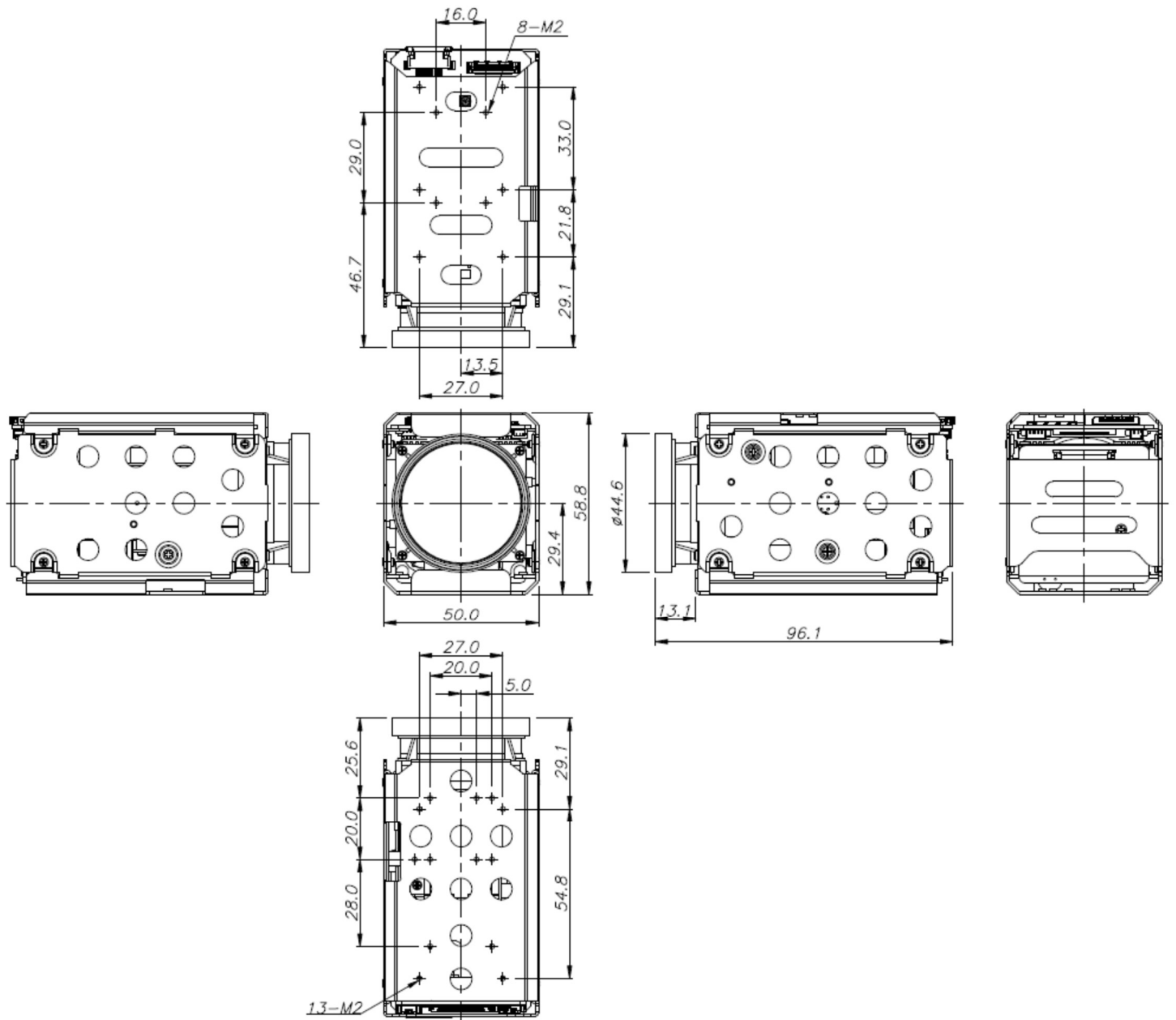



# INTERFACE

## PIN Assign (DTC-Z7830H-LA 1/2.8")

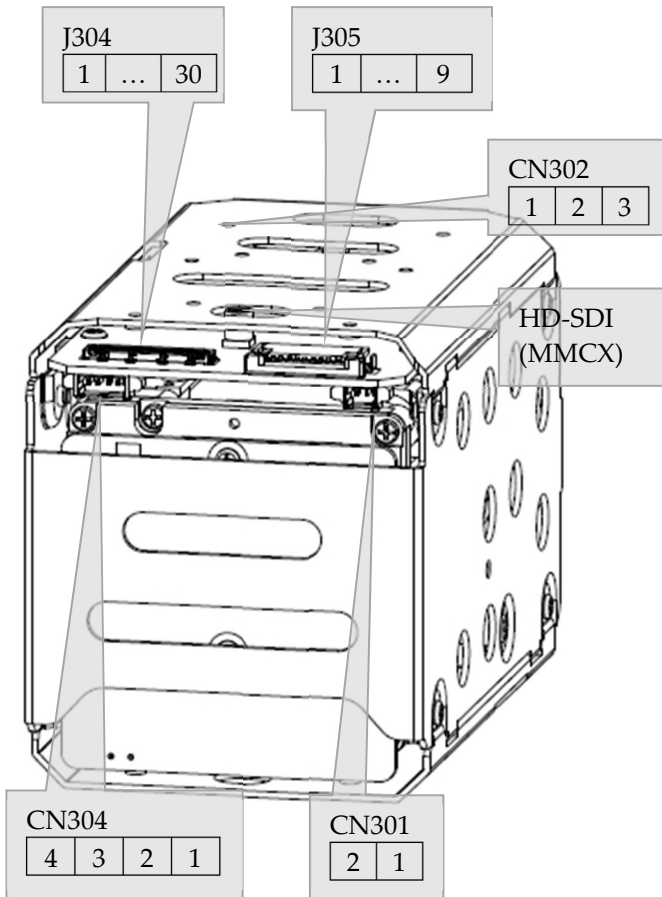

### J305 / Molex 52207-0985

NO	Name	Description
1	GND	(Optional RS485EN or AD KEY)
2	AHD_OUT	HD-AHD OUTPUT
3	GND	
4	CVBS	CVBS OUTPUT
5	GND	
6	DC_IN	DC12V input
7	GND	
8	TXD	5.0V (compatible 3.3V)
9	RXD	5.0V (compatible 3.3V)

### J304 (Micro Co-Axial) / KEL Co. USL00-30L-C

NO	Name	Description
1	TX_OUT3+	
2	TX_OUT3-	
3	TX_CLKOUT+	
4	TX_CLKOUT-	
5	TX_OUT2+	
6	TX_OUT2-	
7	TX_OUT1+	
8	TX_OUT1-	
9	TX_OUT0+	
10	TX_OUT0-	
11	GND	
12	TXD	5.0V (compatible 3.3V)
13	RXD	5.0V (compatible 3.3V)
14	+12V DC	
15	+12V DC	
16	+12V DC	
17	+12V DC	
18	+12V DC	
19	GND	
20	GND	
21	TX_OUT7+	Single out mode : open
22	TX_OUT7-	Single out mode : open
23	TX_OUT6+	Single out mode : open
24	TX_OUT6-	Single out mode : open
25	CVBS	CVBS output
26	RESET_IN	Reset:Low(GND),Normal(1.8V)
27	TX_OUT5+	Single out mode : open
28	TX_OUT5-	Single out mode : open
29	TX_OUT4+	Single out mode : open
30	TX_OUT4-	Single out mode : open

### CN302 (External D&N) / JST : SM03B-SRSS-TB

NO	Name	Description
1	Ext_D&N	External D&N Input
2	GND	
3	+3.3V	+3.3V Out (For Sensor)

### CN304 (AHD) / 53261-0471

NO	Name	Description
1	+12V_IN	DC 12V INPUT
2	GND	GND (DC 12V)
3	AHD_OUT	HD-AHD output
4	GND	GND (HD-AHD)

### CN301 (RS485) / 53261-0271

NO	Name	Description
1	TRX+	RS485 TRX+
2	TRX-	RS485 TRX-

(AD key External Circuit)

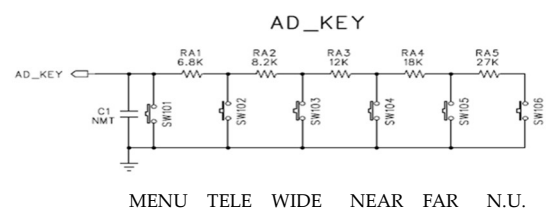

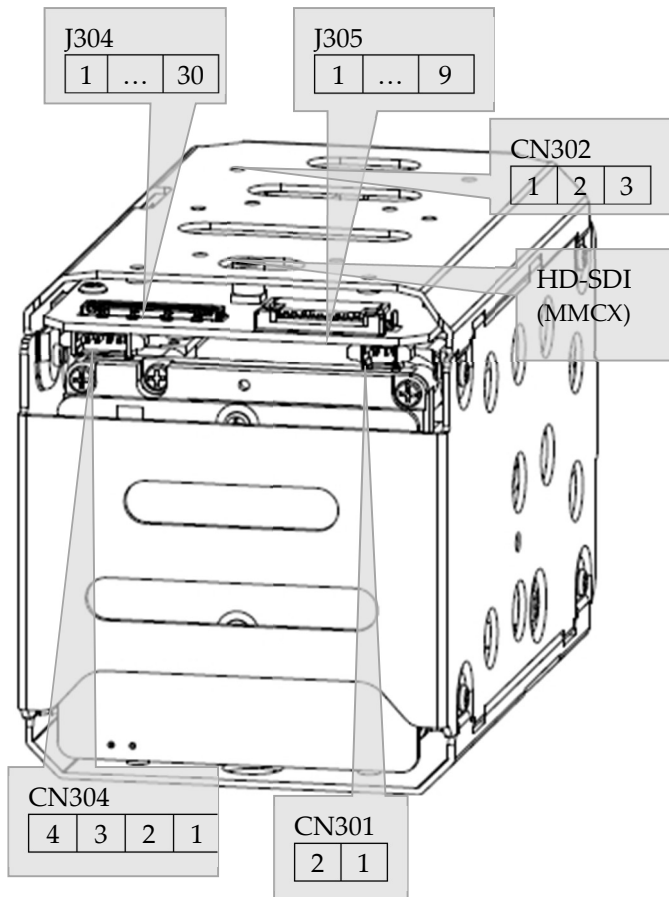

**J304 (Micro Co- Axial) / KEL Co. USL00-30L-C**

NO	Name	Description
1	TX_OUT3+	
2	TX_OUT3-	
3	TX_CLKOUT+	
4	TX_CLKOUT-	
5	TX_OUT2+	
6	TX_OUT2-	
7	TX_OUT1+	
8	TX_OUT1-	
9	TX_OUT0+	
10	TX_OUT0-	
11	GND	
12	TXD	5.0V (compatible 3.3V)
13	RXD	5.0V (compatible 3.3V)
14	+12V DC	
15	+12V DC	
16	+12V DC	
17	+12V DC	
18	+12V DC	
19	GND	
20	GND	
21	TX_OUT7+	Single out mode : open
22	TX_OUT7-	Single out mode : open
23	TX_OUT6+	Single out mode : open
24	TX_OUT6-	Single out mode : open
25	CVBS	CVBS output
26	RESET_IN	Reset:Low(GND),Normal(1.8V)
27	TX_OUT5+	Single out mode : open
28	TX_OUT5-	Single out mode : open
29	TX_OUT4+	Single out mode : open
30	TX_OUT4-	Single out mode : open

**J305 / Molex 52207-0985**

NO	Name	Description
1	GND	(Optional RS485EN or AD KEY)
2	TVI_OUT	HD-TVI OUTPUT
3	GND	
4	CVBS	CVBS OUTPUT
5	GND	
6	DC_IN	DC12V input
7	GND	
8	TXD	5.0V (compatible 3.3V)
9	RXD	5.0V (compatible 3.3V)

**CN302 (External D&N) / JST : SM03B-SRSS-TB**

NO	Name	Description
1	Ext_D&N	External D&N Input
2	GND	
3	+3.3V	+3.3V Out (For Sensor)

**CN304 (TVI) / 53261-0471**

NO	Name	Description
1	+12V_IN	DC 12V INPUT
2	GND	GND (DC 12V)
3	TVI_OUT	HD-TVI output
4	GND	GND (HD-TVI)

**CN301 (RS485) / 53261-0271**

NO	Name	Description
1	TRX+	RS485 TRX+
2	TRX-	RS485 TRX-

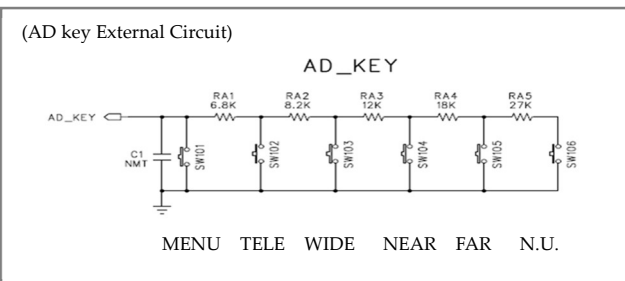

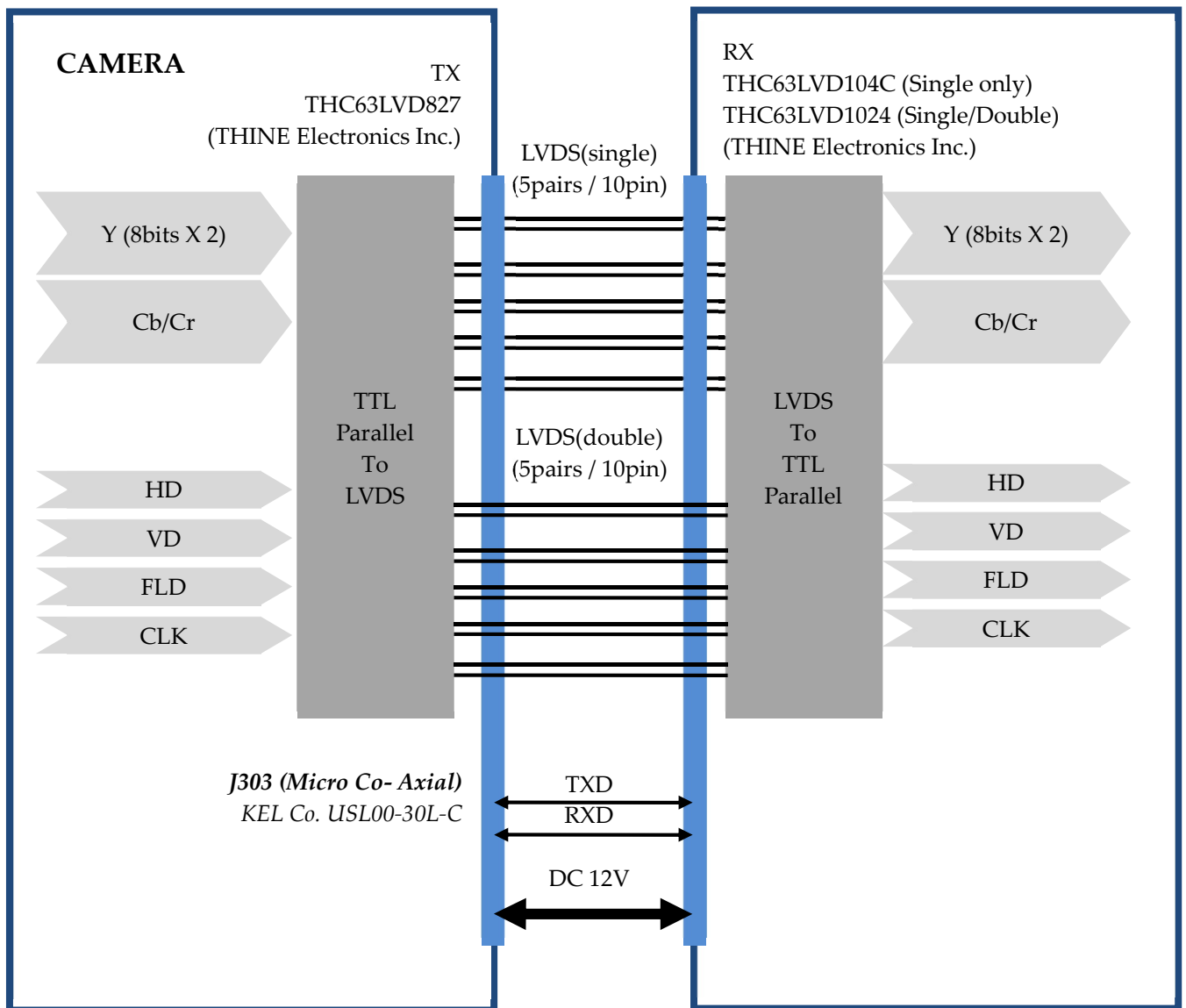

HD Digital Video Sync Signal  
 74.125MHz

Recommended LVDS receiver IC  
 (1) Single Only : THC63LVD104C  
 (2) Single or Double : THC63LVD1024

Select LVDS output mode

- (1) MENU  
 SPECIAL -> SYSTEM -> LVDS MODE : SINGLE/DUAL
- (2) VISCA protocol  
 8x 01 04 24 74 0p 0q FF : pq=00 (single) / pq=01 (double)

(caution) If the frame rate is 25 fps / 30 fps, it works as SINGLE even if LVDS MODE is set to DUAL.  
 However, if the frame rate is 50 fps / 60 fps, LVDS MODE must be set to DUAL to operate as DUAL.

**Single Mode : THC63LVD827 (THINE Electronics Inc.)**

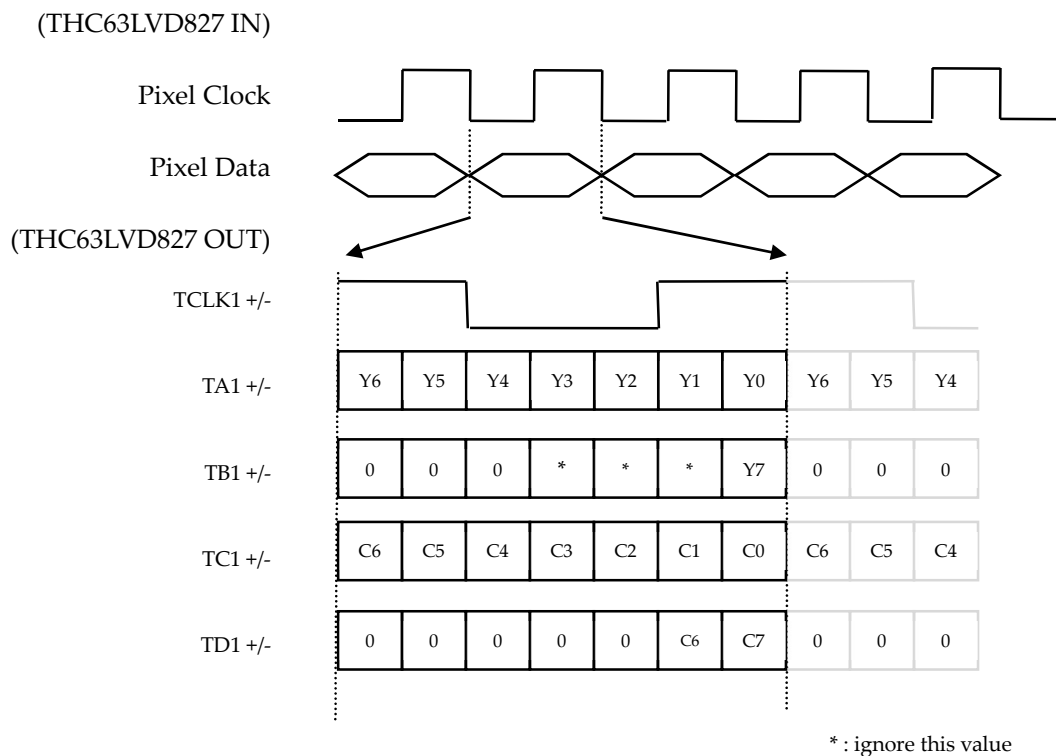

Output Format	Pixel Clock [MHz]	TCLK+ [MHz]
1080p60	148.5	148.5
1080p50	148.5	148.5
1080i60	74.25	74.25
1080i50	74.25	74.25
1080p30	74.25	74.25
1080p25	74.25	74.25
720p60	74.25	74.25
720p50	74.25	74.25
720p30	74.25	74.25
720p25	74.25	74.25

## Double Mode : THC63LVD827 (THINE Electronics Inc.)

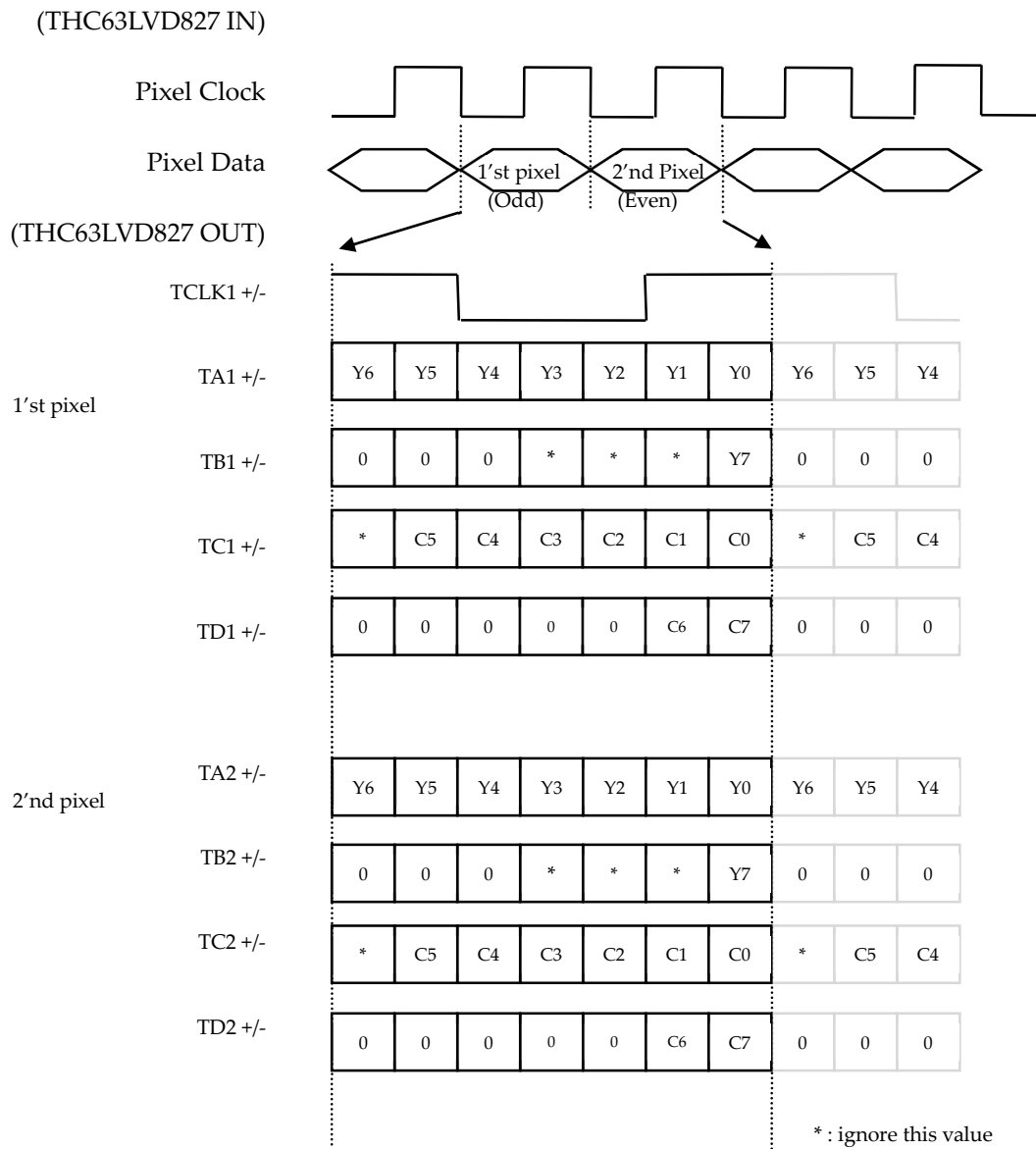

Output Format	Pixel Clock [MHz]	TCLK+ [MHz]
1080p60	148.5	74.25
1080p50	148.5	74.25
1080i60	74.25	37.125
1080i50	74.25	37.125
1080p30	74.25	37.125
1080p25	74.25	37.125
720p60	74.25	37.125
720p50	74.25	37.125
720p30	74.25	37.125
720p25	74.25	37.125

# FUNCTIONS

## Auto Focus Near Limit

You can set the minimum focus distance from 1cm(or 10cm) to infinite. It is available only at high magnification zoom position.

This is called by FOCUS LIMIT or NEAR LIMIT or M.O.D (Minimum object distance). This is mostly used to avoid focusing on objects of close range.

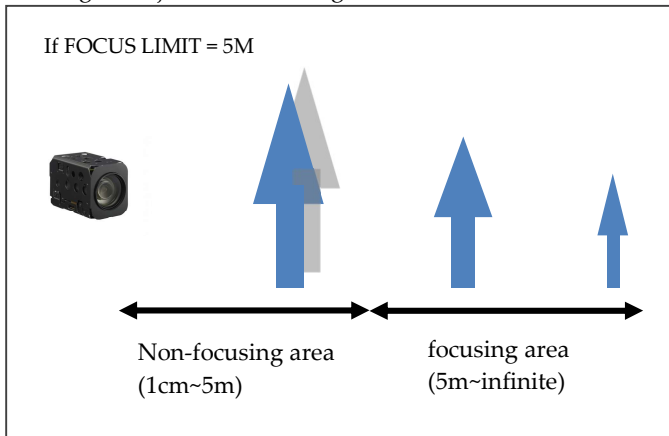

## Auto Focus Mode

- **AUTO**  
When a change in the image is detected, the AF operation is automatically performed.
- **INTERVAL**  
It is used for AF movements carried out at particular intervals.
- **MANUAL**  
Adjust zoom and focus manually.
- **ONESHOT**  
When the zoom is changed, auto focus is executed only once.  
The AF range is from FOCUS LIMIT to infinity.  
It is called by "ONE PUSH" or "ZOOM TRIGGER" mode.
- **PRESET**  
Always focus on the specified subject. When the zoom is changed, auto focus is executed only once. The AF range (=PRESET MARGIN) is limited to a specific range.

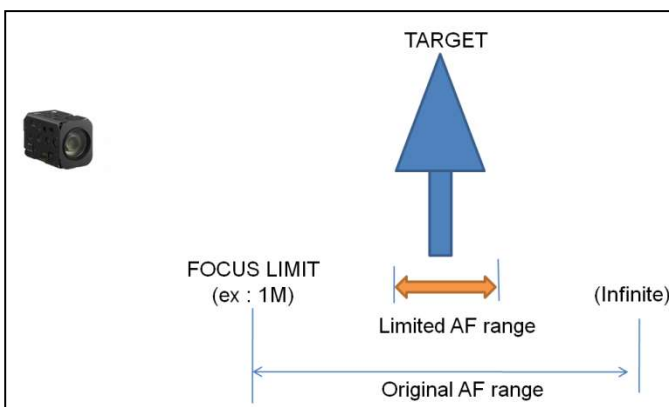

- The PRESET AF mode is useful when you need to focus only on objects of a specific distance that require little PAN / TILT operation after installing the camera.

- The PRESET MARGIN is the AF operating range at the maximum zoom scale. This range is automatically adjusted according to the zoom magnification

### < PRESET setting method - 1 >

- (1) Enter MENU
- (2) Change AF mode to PRESET
- (3) Enter PRESET POSITION menu
- (4) Move to maximum zoom scale (OK is displayed on the screen)
- (5) Adjust focus
- (6) Exit PRESET POSITION menu
- (7) Adjust PRESET MARGIN data (4~255)

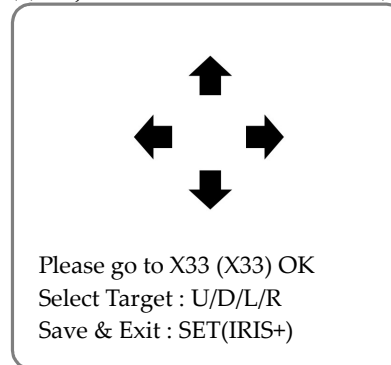

(Preset Target Setting Screen)

### < PRESET setting method - 2 >

KT_PresetAF	Disp. Setting OSD	8x 01 70 02 00 FF
	Cancel & Exit	8x 01 70 02 01 FF
	Save & Exit	8x 01 70 02 02 FF
	Test PRESET	8x 01 70 02 10 FF
	Set Preset AF Range	8x 01 70 03 0p 0q FF

- (1) If you want to output the PRESET POSITION setting screen, send SETTING OSD command.
- (2) To save the current zoom and focus position in the PRESET position, send the SAVE & EXIT command. To end without saving, send CANCEL&EXIT command.
- (3) To save the current zoom and focus position to PRESET position without outputting PRESET POSITION menu, send SAVE & EXIT command.

## Automatic Exposure Mode

- Full Auto mode  
Iris, Gain, Shutter speed can be set automatically.
- Shutter Priority mode  
Variable shutter speed : 1/1(X32)~1/30000  
Auto Iris & Gain
- Iris Priority mode  
Variable Iris : F1.6 ~ Close, 14steps  
Auto Gain & Shutter
- Manual mode  
Variable Iris/Shutter/Gain
- Bright mode  
Variable Iris & Gain, F1.6~58dB  
Shutter speed is maintained at the speed in FULL AUTO or SHUTTER PRIORITY mode.  
The "BRIGHT" mode can be switched to "Full Auto" or "Shutter priority" mode only.

(NOTE) See "Command Setting Values"

## Exposure Compensation

It is a function which offsets the internal reference brightness level used in the AE mode.

CAM_ExpComp	8x 01 04 4E 00 00 0p 0q	pp=compensation level FF
-------------	-------------------------	-----------------------------

(NOTE) See "Command Setting Values"

## Wide Dynamic Range (WDR)

Images with WDR are produced by combining long-exposure signals(normal shutter) with the signal of the high-intensity portions obtained a short-exposure (high-speed shutter).

(NOTE1) When CVBS is connected, WDR automatically turns off and Digital WDR operates.

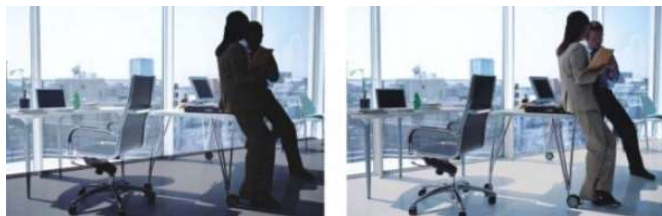

WDR OFF

WDR ON

## High-Light Compensation (HLC)

It's ability to reverse bright points in the picture to black. As an effective approach to recognize vehicle plate number at night, HLC function can detect any spotlight diffused by object-vehicle and compensate it for obtaining clearer image.

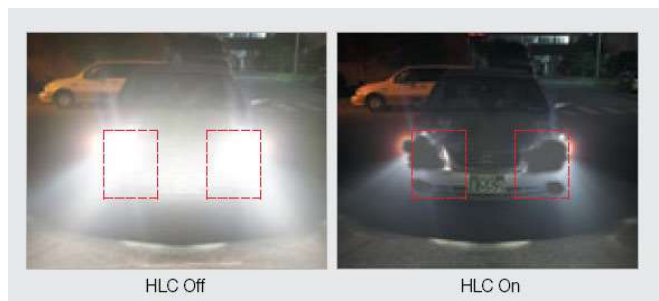

HLC Off

HLC On

## Spot AE

- Available in Full Auto AE mode.
- A particular section of the subject can be designated, and then that portion of the image can be weighted and a value computed so that iris and gain can be optimized to obtain an image.

0	1	2	3	4	5	6	7	8	9	A	B	C	D	E	F
1															
2															
3															
4															
5															
6															
7															
8															
9															
A															
B															
C															
D															
E															
F															

CAM_SpotAE	On	8x 01 04 59 02 FF	Spot AE mode
	Off	8x 01 04 59 03 FF	
	Position	8x 01 04 29 0p 0q 0r 0s FF	pp:X(0-F), rs:Y(0-F)

## Noise Reduction

- 3D-NR
- 2D-NR

## Defog

- Sharpens cloudy images such as fog.

## Slow AE Response

The Slow AE Response function allows you to reduce the exposure response speed.

(example) If the headlights of a car are caught by the camera, the camera automatically adjusts the exposure so that it can shoot a high-intensity subject. Since AE responds slowly, it can be prevent images from being shot.

CAM_AE_Response	8x 01 04 5D pp FF	pp: 01 to 30 default 01
-----------------	-------------------	----------------------------

## Digital Image Stabilizer

This function reduces image blurring caused by vibration

- **RANGE** : Set the compensation range. Up to 30% of the input image range is used, and digital zoom is required up to 1.4 times according to the setting.

- **FILTER**: Correction filter for the worst case of the image (built-in Hold filter). If you increase the setting value, the correction becomes less. If you decrease the setting value, the correction becomes better. However, a malfunction may occur in a moving subject or a low-illuminance / no-pattern image.

- **AUTO C** : Auto Centering to distinguish camera shake from PANNING. It compensates for high frequency vibrations such as tremor and allows the screen to move naturally to the camera's PANNING. In the case of FULL, the camera always corrects the direction in which the image is positioned at the center of the image. In the case of HALF, the center of the correction area is completely corrected (PANNING is ignored) and only the periphery is centered.



(before)

(after)

## Home Position Mode

After power on, you can choose whether to move to the last position before power off or to x1 position.

KT_HomePowerOn	On	8x 01 70 24 02 FF	Moving to x1 position
	Off	8x 01 70 24 03 FF	Move to final position before power off

## Memory Preset

16 sets of camera shooting conditions can be stored and recalled.

- Zoom Position
- Digital Zoom Mode
- Focus Mode
- AE mode
- Shutter control parameters
- Bright , Iris, Gain
- Exposure Compensation mode
- Exposure Level
- Backlight Compensation mode
- Auto Slow Shutter On/Off
- White Balance mode
- Red/Blue Gain
- Aperture Control
- ICR mode, Defog, WDR mode

CAM_Memory	Reset	8x 01 04 3F 00 0p FF	p:Memory Number(0~F)
	Set	8x 01 04 3F 01 0p FF	
	Recall	8x 01 04 3F 02 0p FF	

(See. Custom/Memory Preset Setting Items)

## Custom Preset

As with the memory preset function, the camera shooting conditions can be saved and recalled. The settings are recalled when the power is turned on.

- The above memory preset contents
- Privacy mask, Motion detect , Title
- Flip, mirror, negative, BW, Gamma, DNR, DIS, AF controls, camera ID, HLC, ETC.

CAM_Custom	Reset	8x 01 04 3F 00 7F FF	Starts up in this mode when the power is turned on
	Set	8x 01 04 3F 01 7F FF	
	Recall	8x 01 04 3F 02 7F FF	
	Inactive	8x 01 04 3F 10 7F FF	
	Active	8x 01 04 3F 11 7F FF	

(See. Custom/Memory Preset Setting Items)

(NOTE)

You can decide whether to use a custom preset.

When the product is shipped, custom preset is disabled(inactive mode)

To enable the custom preset, the user must send **SET/RECALL** or **ACTIVE** command.

To disable the custom preset, send **INACTIVE** command.

<Custom Preset Mode>

When the power is turned on,

- **Active** : starts up in the custom preset settings

- **Inactive** : starts up in the settings before the power is turned off

(factory shipment default : Inactive mode)

## User Memory Area

You can use up to 16 bytes to store data such as camera number.



## Exposure Manual Preset

- You can save the current Exposure state and recall it.
- Saving can be done in any mode of Exposure, but recall is only possible in MANUAL mode.
- Provides 8 presets
- You can adjust the brightness automatically in Exposure MANUAL mode by using "One-Push Auto Exposure" command

< example >

(1) Actually current exposure condition



(2) Recall Exposure preset



## White Balance Manual Preset

- You can save the current color state and recall it.
- Saving can be done in any mode of White Balance, but recall is only possible in MANUAL mode.
- Provides 8 presets
- You can adjust the white balance automatically in white balance MANUAL mode by using "One-Push Auto White Balance" command

< example >

(1) Actually current white balance condition



(2) Recall white balance preset



KT_AE_Manual_Preset	8x 01 70 63 0p 0q FF
	p=1 : save current exposure to preset
	p=2 : recall saved exposure preset
	p=3 : clear exposure preset
	q=0~7 : exposure preset number
KT_AE_OnePush	81 01 70 61 00 FF

KT_WB_Manual_Preset	8x 01 70 62 0p 0q FF
	p=1 : save current color to preset
	p=2 : recall saved color preset
	p=3 : clear color preset
	q=0~7 : color preset number
KT_WB_OnePush	81 01 70 60 00 FF

< One-Push Auto Exposure >

- (1) Transmit "KT\_AE\_OnePush" command
- (2) Wait 5 seconds
- (3) If you want to save the current state as a preset, transmit "KT\_AE\_Manual\_Preset SAVE" command

< One-Push Auto White Balance >

- (1) Transmit "KT\_WB\_OnePush" command
- (2) Wait 5 seconds
- (3) If you want to save the current state as a preset, transmit "KT\_WB\_Manual\_Preset SAVE" command

## Position Preset

The current zoom / focus position can be stored in the internal memory and moved to that position if necessary. A total of 256 locations can be stored.

KT_ZoomFocus Preset	Set	8x 01 70 3F 01 0p 0q 0r FF	pqr : preset Number (0x000~0x0FF)
	Recall	8x 01 70 3F 02 0p 0q 0r FF	
	Clear	8x 01 70 3F 03 0p 0q 0r FF	
	Clear All Preset	8x 01 70 3F 0F 00 00 00 FF	Clear all preset data
KT_ZoomFocus PresetInq	8x 09 703F 0n 0n 0n FF	y0 50 0v 0z 0z 0z 0z 0f 0f 0f 0f FF	nnn: preset number (0x000~0x0FF) v : 1(saved), 0(empty) zzzz : zoom position ffff : focus position

## Day & Night Setting

### • AUTO Mode

If the current illumination is darker than the ICR ON level, the IR cut filter is removed. If it is brighter than the ICR OFF level, the IR cut filter is enabled.

ICR ON level = Day To Night level

ICR OFF level = Night To Day level

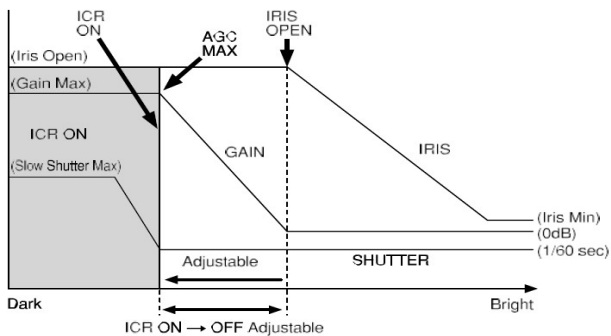

### • DAY Mode (=ICR OFF fixed)

It always maintains the DAY (color) state regardless of the current illumination.

### • NIGHT Mode (=ICR ON fixed)

It always maintains the NIGHT (B/W) state regardless of the current illumination.

### • EXT-L/H Mode

DAY / NIGHT is determined according to the external input signal.

In EXT-H mode, when the input signal level is greater than DAY TO NIGHT LEVEL, it switches to NIGHT.

In EXT-L mode, if the input signal level is lower than DAY TO NIGHT LEVEL, it switches to NIGHT.

KT_DayNightMod e <sup>(*)</sup>	Auto	8x 01 70 04 00 FF
	Day	8x 01 70 04 01 FF
	Night	8x 01 70 04 02 FF
	Ext-High	8x 01 70 04 03 FF
	Ext-Low	8x 01 70 04 04 FF
KT_ExtICRthreshold Id <sup>(*)</sup>	Day->Night(EXT-H)	8x 01 70 05 10 0p 0q FF
	Night->Day(EXT-H)	8x 01 70 05 11 0p 0q FF
	Day->Night(EXT-L)	8x 01 70 05 20 0p 0q FF
	Night->Day(EXT-L)	8x 01 70 05 21 0p 0q FF

## Motion Detect Function

Motion Detect functions instructs the camera to detect movement within monitoring area and then send an alarm signal automatically.

### ◇ Frame

You can set up to 4-frames

Each frame can be set up :

Using VISCA : 16 (horizontally)×8 (vertically) blocks

Using MENU : 60 (horizontally)×34 (vertically) blocks

### ◇ Sending Alarms

- When motion is detected, the Alarm Replay command is issued via the serial command (VISCA) communication line.

- When multiple motions are detected or motion is detected in another frame within the set interval following the original time the alarm was issued, another alarm command is not issued.

- When motion is detected after the interval time elapsed, the alarm is issued again.

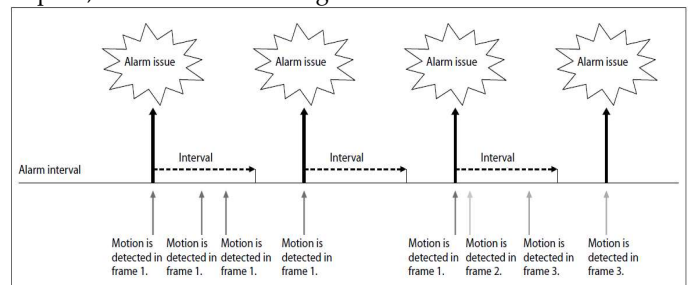

On	8x 01 04 1B 02 FF	Motion Detection On/Off
Off	8x 01 04 1B 03 FF	
Function Set	8x 01 04 1C 0m 0n 0p 0q 0r 0s FF	m: Display mode (when motion is detected) bit0 : frame display bit1 : block display bit2 : Text display n: Detection Frame Set (0 to F) bit0(frame1)~bit3(frame4) pq: Threshold Level (00 to FF) rs: Interval Time set (00 to FF)
Window Set	8x 01 04 1D 0m 0p 0q rr 0s FF	m: Select Detection Frame (0, 1, 2, 3) p: Start Horizontal Position (00 to 0F) q: Start Vertical Position (00 to 07) r: Stop Horizontal Position (01 to 10) s: Stop Vertical Position (01 to 08)
Alarm (Reply)	y0 07 04 1B 0p FF	p: Detection Frame Number

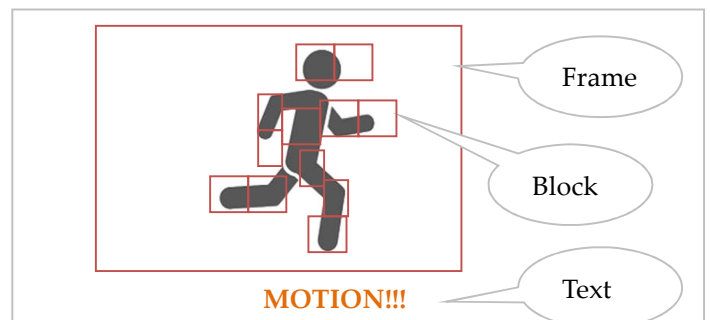

(\*) Blocks are output only within the Frame area.

## Privacy Zone Masking

Privacy Zone masking protects private objects and areas such as house windows, entrances, and exits which are within the camera's range of vision but not subject to surveillance. Privacy zone masking can be masked on the monitor to protect privacy.

- Mask can be set on up to 16 places according to Pan/Tilt positions.
- Interlocking control with zooming.
- Interlocking control with Pan/Tilt.
- Non-interlocking control with Pan/Tilt.

Command Set	Command	Command	Comments
CAM_PrivacyZone	SetMask	8x 01 04 76 mm nn 0r 0r 0s 0s FF	Setting Mask(Size) See "mm: Mask setting list", "nn: Setting", and "rr: w, ss: h" in "Parameters"
	Display	8x 01 04 77 pp pp pp pp FF	Setting Mask Display On/Off See "pp pp pp pp: Mask bit" in "Parameters". pp pp pp pp: Mask setting (0: OFF, 1: ON)
	SetMaskColor	8x 01 04 78 pp pp pp pp qq rr FF	Setting Color of Mask See "pp pp pp pp: Mask bit" and "qq, rr: Color code" in "Parameters". qq: Color setting when setting the Mask bit to 0 rr: Color setting when setting the Mask
	SetPanTiltAngle	8x 01 04 79 0p 0p 0p 0q 0q 0q FF	Setting Pan/Tilt Angle See "Setting pan/tilt angle" in "Parameters". ppp: Pan angle, qq: Tilt angle
	SetPTZMask	8x 01 04 7B mm 0p 0p 0p 0q 0q 0q 0r 0r 0r 0r FF	Setting the direct position of PTZ See "mm: Mask setting list" and "Setting pan/tilt angle" in "Parameters". ppp: Pan, qq: Tilt, rrr: Zoom
	Non_InterlockMask	8x 01 04 6F mm 0p 0p 0q 0q 0r 0r 0s 0s FF	Setting non-interlocking the mask to pan/tilt See "mm: Mask setting list" and "pp:x,qq:y, rr:w, ss:

Inquiry Command	Command Packet	Inquiry Packet	Comments
CAM_PrivacyDisplayInq	8x 09 04 77 FF	y0 50 pp pp pp pp FF	Inquiry about the status of Setting Mask Display On/ Off See "pp pp pp pp: Mask bit" in "Parameters". 1:On, 0:Off
CAM_PrivacyPanTiltInq	8x 09 04 79 FF	y0 50 0p 0p 0p 0q 0q 0q FF	Inquiry about the pan/tilt position currently set See "Setting pan/tilt angle" in "Parameters". ppp: Pan, qq: Tilt
CAM_PrivacyPTZInq	8x 09 04 7B mm FF	y0 50 0p 0p 0p 0q 0q 0q 0r 0r 0r 0r FF	Inquiry about pan/tilt/zoom position at the mm Mask setting See "mm: Mask setting list" and "Setting pan/tilt angle" in "Parameters". ppp: Pan position, qq: Tilt Position rrr: Zoom
CAM_PrivacyMonitorInq	8x 09 04 6F FF	y0 50 pp pp pp pp FF	Inquiry about the mask currently displayed See "pp pp pp pp: Mask bit" in "Parameters".

- Mask Number : A=0x00, B=0x01,...W=0x16, X=0x17 (total 24 masks)
- Mask Bit & Mask List(mm)

	pp pp pp pp (mask bit) or mm(Mask list)																															
byte	pp								pp								pp								pp							
bit	7	6	5	4	3	2	1	0	7	6	5	4	3	2	1	0	7	6	5	4	3	2	1	0	7	6	5	4	3	2	1	0
Mask	-	-	-	-	-	-	-	-	-	-	-	-	P	O	N	M	-	-	L	K	J	I	H	G	-	-	F	E	D	C	B	A
List(mm)																			0B	0A	09	08	07	06			05	04	03	02	01	00

The priority order of the mask display is in the sequence from A (highest) to P (lowest).

● Pan/Tilt Angle

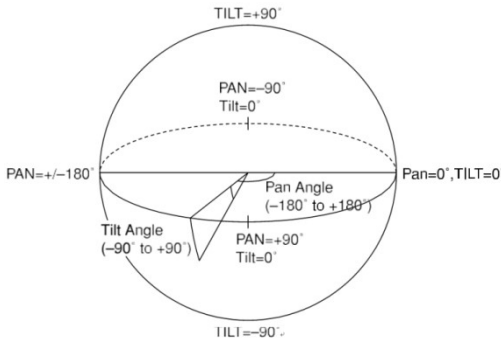
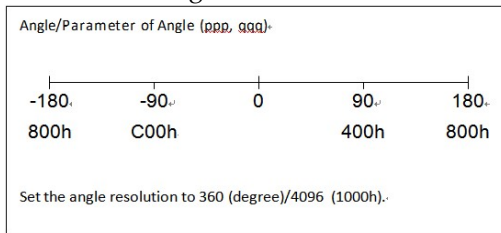

- ✓ You can use the tilt angle at which you can set the mask between -90 to +90 degrees. But the recommended tilt angle is between -70 to +70 degrees.
- ✓ It is recommended that you set the size to at least twice the size of the object (height and width).

● Mask Color (qq, rr)

Mask (Color)	Normal	Translucence
Black	00h	10h
Gray1	01h	11h
Gray2	02h	12h
Gray3	03h	13h
Gray4	04h	14h
Gray5	05h	15h
Gray6	06h	16h
White	07h	17h
Red	08h	18h
Green	09h	19h
Blue	0Ah	1Ah
Cyan	0Bh	1Bh
Yellow	0Ch	1Ch
Magenta	0Dh	1Dh

● Mask Size : Width/Height

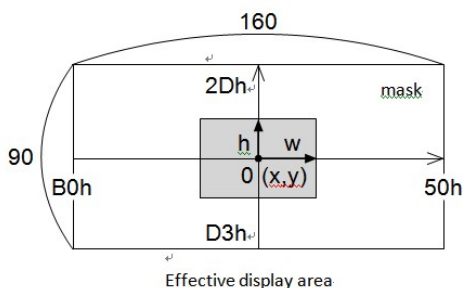

**Title / Function Display**

The user can output desired characters on the screen and can also choose the output font size.

See. "CAM\_Title", "CAM\_MultiLineTitle", "CAM\_EvenLineTitle"

● Select Font Size

KT_FontSize	Normal	8x 01 70 15 30 FF
	Big	8x 01 70 15 31 FF

(\*)Font size default varies by model

Big Size : 11 lines, 40columns

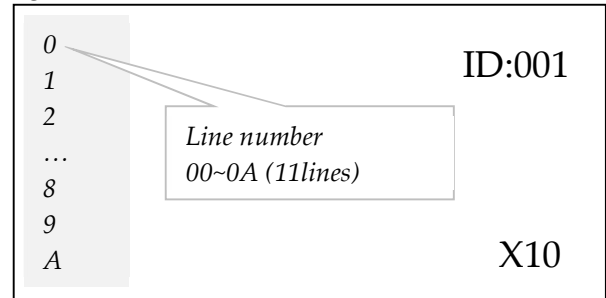

Normal Size : 21 lines, 49 columns

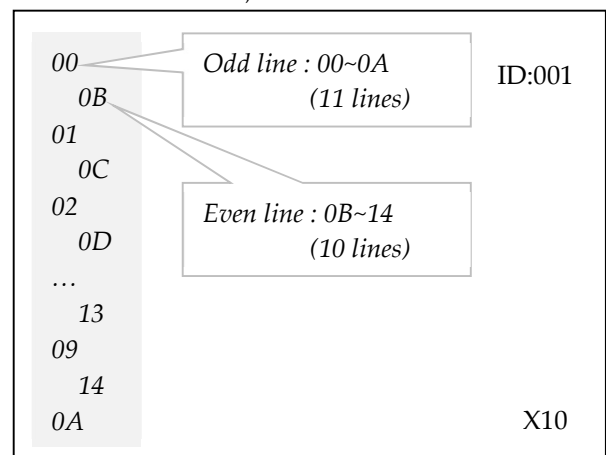

● Function OSD display

The current setting status of the camera is displayed on the screen.

CAM_Display	On	8x 01 04 15 02 FF
	Off	8x 01 04 15 03 FF

(example)

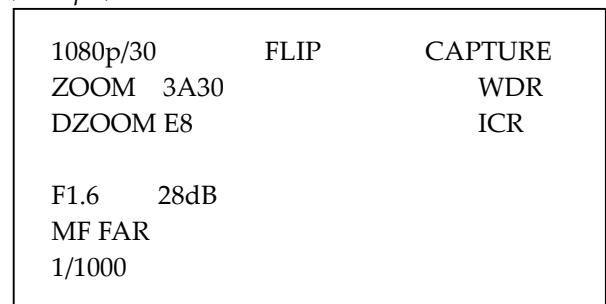

# COMMAND LIST

## Overview of RS232 Communication

- Communication speed :  
2400/4800/9600/19200,38400/57600/115200bps
- Data bits : 8
- Start bit : 1
- Stop bit : 1
- Non parity
- Flow control using XON/XOFF and RTS/CTS, etc., is not supported

## Command & Inquiry

- **Command**  
Sends operational commands to the camera
  - **Inquiry**  
Used for inquiring about the current state of the camera
- |         | Command Packet  | Note  |
|---------|-----------------|---|
| Inquiry | 8X QQ RR ... FF | QQ <sub>1</sub> = Command/Inquiry,<br>RR <sub>2</sub> = category code |
- 1) QQ = 01 (Command), 09 (Inquiry)
  - 2) RR = 00 (Interface), 04 (camera 1),  
06 (Pan/Tilter), 07 (camera 2)
- X = 1 to 7 : camera address

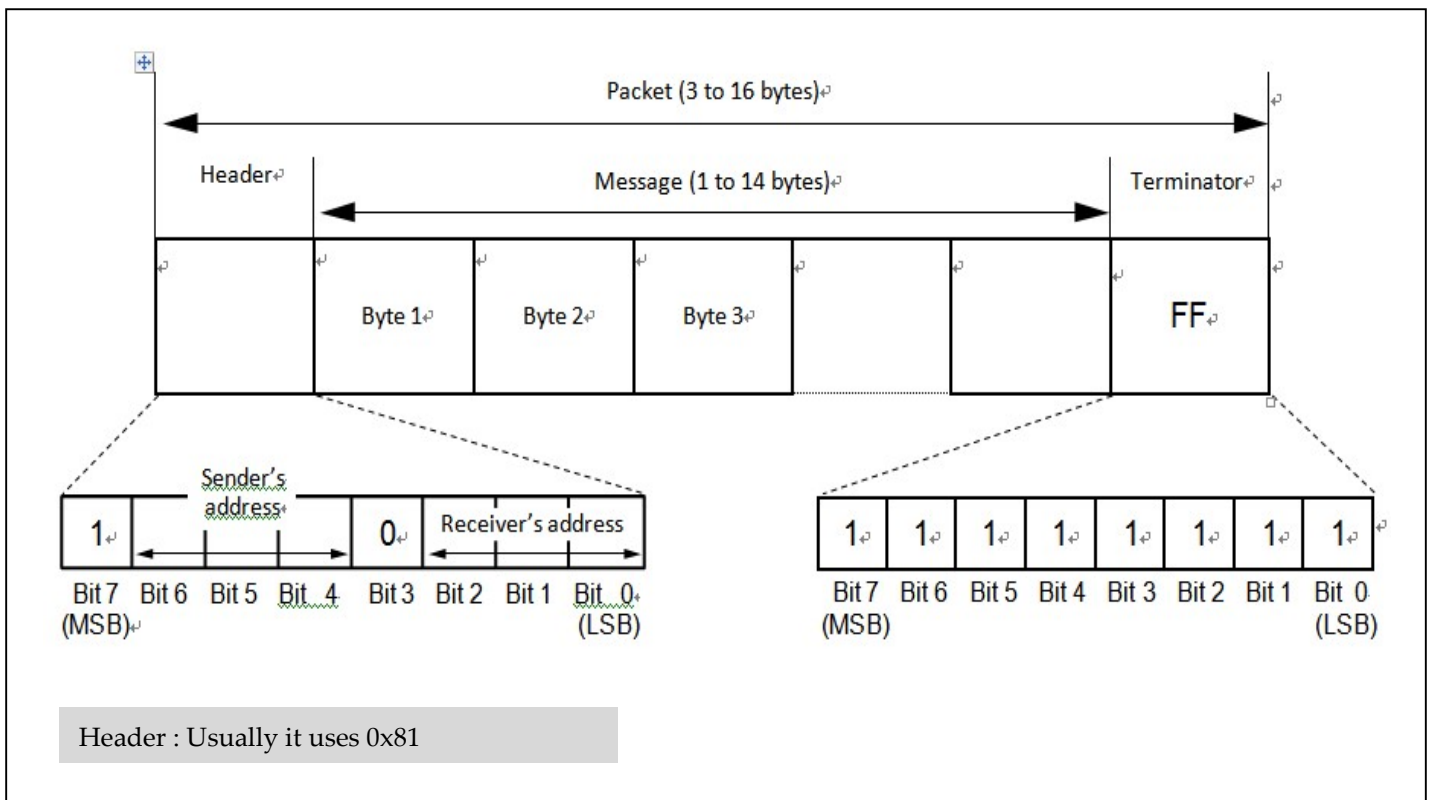

## Inquiries

- **ACK message**

Returned by the camera when it receives a command.  
No ACK message is returned for inquiries.

- **Completion message**

Returned by the camera when execution of commands or inquiries is completed. In the case of inquiry commands, it will contain reply data for the inquiry after the 3rd byte of the packet. If the ACK message is omitted, the socket number will contain 0.

	Reply Packet	Note
Ack	X0 4Y FF	Y = socket
Completion	X0 5Y FF	Y = socket
Completion (Inquiries)	X0 5Y ... FF	Y = socket

X = 9 to F: camera address + 8

- **Error message**

Error Packet	Description
X0 6Y 01 FF	Message length error (>14 bytes)
X0 6Y 02 FF	Syntax Error
X0 6Y 03 FF	Command Buffer Full
X0 6Y 04 FF	Command cancelled
X0 6Y 05 FF	No socket
X0 6Y 41 FF	Command not executable

X = 9 to F: camera address + 8, Y = socket number

- **Cam\_VersionInq**

Returns information on the VISCA interface.

Inquiry	Packet	Reply	Description
Cam_VersionInq	8X 09 00 02 FF	Y0 50 GG GG HH HH JJ JJ KK FF	GGGG=Vender ID HHHH=Model ID JJJJ = ROM version KK=Maximum socket # (=02)

X = 1 to 7 : camera address (For inquiry packet)

X = 9 to F : camera address +8 (For reply packet)

GGGG = **0x0078** (vendor=DYNA)

HHHH : Model Code

HZ7833M-LT : 0467

HZ7833M-LA : 0467

JJJJ : ex) 0123 = Ver1.2.3

- **Network change**

Camera automatically transmits when power is turned on.

**Packet**

Network change X0 38 FF (X=9)

## Command / ACK Example

Command	Command Message	Reply Message	Comments
General Command	81 01 04 38 02 FF (Example)	90 41 FF (ACK)+90 51 FF (Completion) 90 42 FF 90 52 FF	Returns ACK when a command has been accepted, and Completion when a command has been executed.
	81 01 04 38 FF (Example)	90 60 02 FF (Syntax Error)	Accepted a command which is not supported or a command lacking parameters.
	81 01 04 08 02 FF (Example)	90 61 41 FF (Command Not Executable) 90 62 41 FF	Could not execute the command in the current mode.
Inquiry Command	81 09 04 38 FF (Example)	90 50 02 FF (Completion)	ACK is not returned for the inquiry command.
	81 09 05 38 FF (Example)	90 60 02 FF (Syntax Error)	Accepted an incompatible command.
Address Set	88 30 01 FF	88 30 02 FF	Returned the device address to +1.
IF_Clear (Broadcast)	88 01 00 01 FF	88 01 00 01 FF	Returned the same command.
IF_Clear (For x)	8x 01 00 01 FF	z0 50 FF (Completion)	ACK is not returned for this command.

## CAMERA COMMAND LIST

Command Set	Command	Command Packet	Comments	
AddressSet	Broadcast	88 30 01 FF	Address setting	
IF_Clear	Broadcast	88 01 00 01 FF	I/F Clese	
CommandCancel	-	8x 2p FF	p: Socket No. (=1 or 2)	
CAM_Power	On	8x 01 04 00 02 FF	Power ON/OFF	
	Off (Standby)	8x 01 04 00 03 FF		
CAM_Zoom	Stop	8x 01 04 07 00 FF	p=0 (Low) to 7 (High) pqrs: Zoom Position zzzz : zoom position ffff : focus position	
	Tele (Standard)	8x 01 04 07 02 FF		
	Wide (Standard)	8x 01 04 07 03 FF		
	Tele (Variable)	8x 01 04 07 2p FF		
	Wide (Variable)	8x 01 04 07 3p FF		
	Direct	8x 01 04 47 0p 0q 0r 0s FF		
	Direct Zoom/Focus	8x 01 04 47 0z 0z 0z 0z 0f 0f 0f 0f FF		
CAM_DZoom	On	8x 01 04 06 02 FF	Digital zoom ON/OFF	
	Off	8x 01 04 06 03 FF		
	Combine Mode	8x 01 04 36 00 FF	Optical/Digital Zoom Combined	
	Separate Mode	8x 01 04 36 01 FF	Optical/Digital Zoom Separate	
	Stop	8x 01 04 06 00 FF		
	Tele (Variable)	8x 01 04 06 2p FF	p=0 (Low) to 7 (High)	
	Wide (Variable)	8x 01 04 06 3p FF	* Enabled during Separate Mode	
	x1/Max	8x 01 04 06 10 FF	x1/MAX Magnification Switchover * Enabled during Separate Mode	
Direct	8x 01 04 46 00 00 0p 0q FF	pq: D-Zoom Position * Enabled during Separate Mode		
CAM_Focus	Stop	8x 01 04 08 00 FF	p=0 (Low) to 7 (High) pqrs: Focus Position AF ON/OFF	
	Far (Standard)	8x 01 04 08 02 FF		
	Near (Standard)	8x 01 04 08 03 FF		
	Far (Variable)	8x 01 04 08 2p FF		
	Near (Variable)	8x 01 04 08 3p FF		
	Direct	8x 01 04 48 0p 0q 0r 0s FF		
	Auto Focus	8x 01 04 38 02 FF		
	Manual Focus	8x 01 04 38 03 FF		
	Auto/Manual	8x 01 04 38 10 FF		
	One Push Trigger	8x 01 04 18 01 FF		One Push AF Trigger
	Infinity	8x 01 04 18 02 FF		Forced infinity
Near Limit	8x 01 04 28 0p 0q 0r 0s FF	pqrs: Focus Near Limit Position		
AF Sensitivity	Normal	8x 01 04 58 02 FF	AF Sensitivity High/Low	
	Low	8x 01 04 58 03 FF		
CAM_AFMode	Normal AF	8x 01 04 57 00 FF	AF Movement Mode pq: Movement Time, rs: Interval	
	Interval AF	8x 01 04 57 01 FF		
	Zoom Trigger AF	8x 01 04 57 02 FF		
	PRESET	8x 01 04 57 03 FF		
	Active/Interval Time	8x 01 04 27 0p 0q 0r 0s FF		
CAM_IRCorrection	Standard	8x 01 04 11 00 FF	FOCUS IR compensation data switching	
	IR Light	8x 01 04 11 01 FF		
CAM_ZoomFocus	Direct	8x 01 04 47 0p 0q 0r 0s 0t 0u 0v 0w FF	pqrs: Zoom Position tuvw: Focus Position	
CAM_Initialize	Lens	8x 01 04 19 01 FF	Lens Initialization Start	
	Camera	8x 01 04 19 03 FF	Camera reset	
CAM_WB	Auto	8x 01 04 35 00 FF	Normal Auto	
	Indoor	8x 01 04 35 01 FF	Indoor mode	
	Outdoor	8x 01 04 35 02 FF	Outdoor mode	
	One Push WB	8x 01 04 35 03 FF	One Push WB mode	
	ATW	8x 01 04 35 04 FF	Auto Tracing White Balance	
	Manual	8x 01 04 35 05 FF	Manual Control mode	
	One Push Trigger	8x 01 04 10 05 FF	One Push WB Trigger	
CAM_RGain	Reset	8x 01 04 03 00 FF	Manual Control of R Gain	

	Up	8x 01 04 03 02 FF		
	Down	8x 01 04 03 03 FF		
	Direct	8x 01 04 43 00 00 0p 0q FF	pq: R Gain, 0x00-0xff	
CAM_BGain	Reset	8x 01 04 04 00 FF	Manual Control of B Gain	
	Up	8x 01 04 04 02 FF		
	Down	8x 01 04 04 03 FF		
	Direct	8x 01 04 44 00 00 0p 0q FF		pq: B Gain, 0x00-0xff
CAM_AE	Full Auto	8x 01 04 39 00 FF	Automatic Exposure mode	
	Manual	8x 01 04 39 03 FF	Manual Control mode	
	Shutter Priority	8x 01 04 39 0A FF	Shutter Priority Automatic Exposure mode	
	Iris Priority	8x 01 04 39 0B FF	Iris Priority Automatic Exposure mode	
	Bright	8x 01 04 39 0D FF	Bright Mode (Manual control)	
CAM_SlowShutter	Auto	8x 01 04 5A 02 FF	Auto Slow Shutter ON/OFF	
	Manual	8x 01 04 5A 03 FF		
CAM_Shutter	Reset	8x 01 04 0A 00 FF	Shutter Setting	
	Up	8x 01 04 0A 02 FF		
	Down	8x 01 04 0A 03 FF		
	Direct	8x 01 04 4A 00 00 0p 0q FF		pq: Shutter Position
CAM_Iris	Reset	8x 01 04 0B 00 FF	Iris Setting	
	Up	8x 01 04 0B 02 FF		
	Down	8x 01 04 0B 03 FF		
	Direct	8x 01 04 4B 00 00 0p 0q FF		pq: Iris Position
CAM_Gain	Reset	8x 01 04 0C 00 FF	Gain Setting	
	Up	8x 01 04 0C 02 FF		
	Down	8x 01 04 0C 03 FF		
	Direct	8x 01 04 4C 00 00 0p 0q FF		pq: Gain Position, 0x00-0x1E, See GAIN POS.
	Gain Limit	8x 01 04 2C pp FF		pp: Gain Position, 0x00-0x1E, See GAIN LIMIT
CAM_Bright	Reset	8x 01 04 0D 00 FF	Bright Setting	
	Up	8x 01 04 0D 02 FF		
	Down	8x 01 04 0D 03 FF		
	Direct	8x 01 04 4D 00 00 0p 0q FF		pq: Bright Position
CAM_ExpComp	On	8x 01 04 3E 02 FF	Exposure Compensation ON/OFF	
	Off	8x 01 04 3E 03 FF		
	Reset	8x 01 04 0E 00 FF	Exposure Compensation Amount Setting	
	Up	8x 01 04 0E 02 FF		
	Down	8x 01 04 0E 03 FF		
	Direct	8x 01 04 4E 00 00 0p 0q FF		pq: ExpComp Position, 0x00-0x0E
CAM_BackLight	On	8x 01 04 33 02 FF	Back Light Compensation ON/OFF	
	Off	8x 01 04 33 03 FF		
CAM_AE_Response	Direct	8x 01 04 5D pp FF	pp: Automatic Exposure Response Setting (01 to 30), default value: 01	
CAM_WD	On	8x 01 04 3D 02 FF	Wide-D ON/OFF	
	Off	8x 01 04 3D 03 FF		
	Set Parameter	8x 01 04 2D 00 00 00 0s 00 00 00 00 FF	s: Blown-out highlight correction level (0:low, 1:middle, 2:high)	
CAM_Aperture (sharpness level)	Reset	8x 01 04 02 00 FF	Aperture Control (sharpness)	
	Up	8x 01 04 02 02 FF		
	Down	8x 01 04 02 03 FF		
	Direct	8x 01 04 42 00 00 0p 0q FF		pq: Aperture Gain (0x00-0x0F)
CAM_HR	On	8x 01 04 52 02 FF	High-Resolution Mode ON/OFF	
	Off	8x 01 04 52 03 FF		
CAM_NR	–	8x 01 04 53 0p FF	p: NR Setting (0: OFF, level 1 to 5)	
CAM_Gamma	–	8x 01 04 5B 0p FF	p: Gamma setting (0: Standard, 1 to 6) See. GAMMA POSITION	
CAM_HighSensitivity	On	8x 01 04 5E 02 FF	High Sensitivity mode ON/OFF	
	Off	8x 01 04 5E 03 FF		
CAM_LR_Reverse	On	8x 01 04 61 02 FF	Mirror Image ON/OFF	
	Off	8x 01 04 61 03 FF		
CAM_Freeze	On	8x 01 04 62 02 FF	Still Image ON/OFF	
	Off	8x 01 04 62 03 FF		
CAM_PictureEffect	Off	8x 01 04 63 00 FF	Picture Effect Setting (* do not support neg.art)	
	Neg.Art	8x 01 04 63 02 FF		
	B&W	8x 01 04 63 04 FF		
CAM_PictureFlip	On	8x 01 04 66 02 FF	Picture flip ON/OFF	
	Off	8x 01 04 66 03 FF		
CAM_ICR	On	8x 01 04 01 02 FF	Infrared Mode ON(night)/OFF(day)	



	Off	8x 01 04 01 03 FF	
CAM_AutoICR	On	8x 01 04 51 02 FF	Auto dark-field mode On/Off
	Off	8x 01 04 51 03 FF	
	Threshold	8x 01 04 21 00 00 0p 0q FF	pp: ICR ON → OFF Threshold Level (Night->Day)
	Threshold	8x 01 04 41 00 00 0p 0q FF	pp: ICR OFF → ON Threshold Level (Day->Night)
CAM_AutoICRAlarmReply	On	8x 01 04 31 02 FF	Auto ICR switching Alarm ON/OFF
	Off	8x 01 04 31 03 FF	
	(Reply)	y0 07 04 31 02 FF	ICR OFF → ON (Night->Day)
		y0 07 04 31 03 FF	ICR ON → OFF (Day->Night)
CAM_MemSave	Write	8x 01 04 23 0X 0p 0p 0q 0q FF	X: 00 to 07 (Address), total 16 byte ppqq: 0x0000 to 0xFFFF (Data)
CAM_Display	On	8x 01 04 15 02 FF (8x 01 06 06 02 FF)	Display ON/OFF (function OSD display)
	Off	8x 01 04 15 03 FF (8x 01 06 06 03 FF)	Function OSD :
	On/Off	8x 01 04 15 10 FF (8x 01 06 06 10 FF)	- Display item : Zoom Ratio, Camera ID Framerate, AE mode, WB mode, Exposure Data
CAM_Title  <i>Total 21 lines</i>  <i>See. "Title/Function display"</i>	Title Set1	8x 01 04 73 00 mm nn pp qq 00 00 00 00 00 00 FF	mm : V-position(0x00~0x14) , nn:H-position (00~28) pp:color, qq:blink
	Title Set2	8x 01 04 73 01 mm nn pp qq rr ss tt uu vv ww FF	mm~ww : setting of display characters (1st to 10st)
	Title Set3	8x 01 04 73 02 mm nn pp qq rr ss tt uu vv ww FF	mm~ww : setting of display characters (11st to 20st)
	Title Set4	8x 01 04 73 07 01 02 03 04 05 06 07 08 09 10 11 12 13 14 15 16 17 18 19 20 21 22 23 24 25 26 27 28 29 30 FF	mm~ww : setting of display characters (1st to 30st)
	Title Clear	8x 01 04 74 00 FF	Title Setting Clear (clear all lines)
	On	8x 01 04 74 02 FF	Title Display On (display all lines)
	Off	8x 01 04 74 03 FF	Title Display Off (display off all lines)
CAM_MultiLineTitle  <i>See. "Title/Function display"</i>  <i>(Big Font or Normal Font Odd Line )</i>  L = 0x0 = Line 00 0x1 = Line 01 ... 0x9 = Line 09 0xA = Line 0A	Title Set1	8x 01 04 73 1L 00 nn pp qq 00 00 00 00 00 00 FF	L: Line Number (0x0~0xA) nn: H-position → nn : 00~0x28 pp: Color, qq: Blink
	Title Set2	8x 01 04 73 2L mm nn pp qq rr ss tt uu vv ww FF	L: Line Number (0x0~0xA) mnpqrstuvw: Setting of characters (1 to 10)
	Title Set3	8x 01 04 73 3L mm nn pp qq rr ss tt uu vv ww FF	L: Line Number (0x0~0xA) mnpqrstuvw: Setting of characters (11 to 20)
	Title Set4	8x 01 04 73 7L 01 02 03 04 05 06 07 08 09 10 11 12 13 14 15 16 17 18 19 20 21 22 23 24 25 26 27 28 29 30 31 32 33 34 35 36 37 38 39 40 41 42 43 FF	L: Line Number (0x0~0xA) 01~30 : Setting of characters (1 to 43)
	Title Clear	8x 01 04 74 1p FF	Title Clear, Display On/Off
	On	8x 01 04 74 2p FF	p:0x0~0xA, F= all lines (line 00~0A)
	Off	8x 01 04 74 3p FF	
CAM_EvenLineTitle  <i>See. "Title/Function display"</i>  <i>(Normal Font Even Line)</i>  L = 0x0 = Line 0B 0x1 = Line 0C ... 0x8 = Line 13 0x9 = Line 14	Title Set1A	8x 01 04 73 4L 00 nn pp qq 00 00 00 00 00 00 FF	L: Line Number (0x0~0x9) nn: H-position → nn : 00~0x28 pp: Color, qq: Blink
	Title Set2A	8x 01 04 73 5L mm nn pp qq rr ss tt uu vv ww FF	L: Line Number (0x0~0x9) mnpqrstuvw: Setting of characters (1 to 10)
	Title Set3A	8x 01 04 73 6L mm nn pp qq rr ss tt uu vv ww FF	L: Line Number (0x0~0x9) mnpqrstuvw: Setting of characters (11 to 20)
	Title Set4A	8x 01 04 73 8L 01 02 03 04 05 06 07 08 09 10 11 12 13 14 15 16 17 18 19 20 21 22 23 24 25 26 27 28 29 30 31 32 33 34 35 36 37 38 39 40 41 42 43 FF	L: Line Number (0x0~0x9) 01~30 : Setting of characters (1 to 43)
	Title Clear	8x 01 04 74 4p FF	Title Clear, Display On/Off
	On	8x 01 04 74 5p FF	p:0x0~0x9, F= all lines (line 0B ~ 14)
	Off	8x 01 04 74 6p FF	
CAM_Mute	On	8x 01 04 75 02 FF	Muting ON/OFF
	Off	8x 01 04 75 03 FF	
	On/Off	8x 01 04 75 10 FF	
CAM_PrivacyZone	SetMask	8x 01 04 76 mm nn 0r 0r	mm: Mask Settings nn 00: Modify, 01: New

		0s 0s FF	rr: W, ss: H
	Display	8x 01 04 77 pp pp pp pp FF	Mask Display ON/OFF pp pp pp pp: Mask Settings (0: OFF, 1: ON)
	SetMaskColor	8x 01 04 78 pp pp pp pp qq rr FF	pp pp pp pp: Mask Color Settings qq: Color Setting when 0 is selected rr: Color Setting when 1 is selected
	SetPanTiltAngle	8x 01 04 79 0p 0p 0p 0q 0q 0q FF	Pan/Tilt Angle Settings ppp: Pan qqq: Tilt
	SetPTZMask	8x 01 04 7B mm 0p 0p 0p 0q 0q 0q 0r 0r 0r 0r FF	Pan/Tilt/Zoom Settings for Mask ppp: Pan, qqq: Tilt, rrrr: Zoom
	Non_InterlockMask	8x 01 04 6F mm 0p 0p 0q 0q 0r 0r 0s 0s FF	mm: Non_Interlock Mask Settings pp: X, q: Y, rr: W, ss: H
CAM_IDWrite	—	8x 01 04 22 0p 0q 0r 0s FF	pqrs: Camera ID (=0000 to FFFF)
CAM_MD	On	8x 01 04 1B 02 FF	Motion Detection On/Off
	Off	8x 01 04 1B 03 FF	
	Function Set	8x 01 04 1C 0m 0n 0p 0q 0r 0s FF	m: Display mode (when motion is detected) bit0 : frame display bit1 : block display bit2 : Text display n: Detection Frame Set (0 to F) bit0(frame1)~bit3(frame4) pq: Threshold Level (00 to FF) rs: Interval Time set (00 to FF)
	Window Set	8x 01 04 1D 0m 0p 0q rr 0s FF	m: Select Detection Frame (0, 1, 2, 3) p: Start Horizontal Position (00 to 0F) q: Start Vertical Position (00 to 07) r: Stop Horizontal Position (01 to 10) s: Stop Vertical Position (01 to 08)
	Alarm (Reply)	y0 07 04 1B 0p FF	p: Detection Frame Number
CAM_Continuous ZoomPosReply	On	8x 01 04 69 02 FF	ZoomPosition data Continuous Output On/Off
	Off	8x 01 04 69 03 FF	
	(Reply)	y0 07 04 69 0p 0p 0q 0q 0q 0q FF	pp: D-Zoom Position * 00: When Zoom Mode is Combine qqqq: Zoom Position
CAM_ZoomPos ReplyIntervalTimeSet	—	8x 01 04 6A 00 00 0p 0p FF	pp: Zoom Position continuous output Interval Time [Vertical timing]
CAM_Continuous FocusPosReply	On	8x 01 04 16 02 FF	Focus Position data Continuous Output On/Off
	Off	8x 01 04 16 03 FF	
	(Reply)	y0 07 04 16 00 00 0p 0p 0p 0p FF	pppp: Focus Position
CAM_FocusPos ReplyIntervalTimeSet	—	8x 01 04 1A 00 00 0p 0p FF	pp: Focus Position continuous output Interval Time [Vertical timing]
CAM_ExtAutoICR_thresh old	ICR ON -> OFF	8x 01 04 1F 21 00 00 0p 0q FF	pq : ICR ON -> OFF threshold when Auto ICR is on pq = 00h ~ 1Bh (Night → Day threshold)
	ICR OFF -> ON	8x 01 04 1F 21 01 00 0p 0q FF	pq : ICR OFF -> ON threshold when Auto ICR is on pq = 01h ~ 1Ch (Day→Night threshold)
CAM_RegisterValue	—	8x 01 04 24 mm 0p 0p FF	mm: Register No. (=00-7F) pp: Register Value (=00-7F) <b>See the "Register setting"</b>
CAM_ColorGain	Direct	8x 01 04 49 00 00 00 0p FF	p: Color Gain setting 0h (60%) to Eh (200%)
CAM_ColorHue	Direct	8x 01 04 4F 00 00 00 0p FF	p: Color Hue setting 0h (- 14 ddegrees) to Eh (+14 degrees)
CAM_Stablizer	On	8x 01 04 34 02 FF	Digital Image Stabilizer
	Off	8x 01 04 34 03 FF	
CAM_Defog	On	8x 01 04 37 02 0p FF	Defog On/Off p:defog level(1:low,2:middle,3:high)
	Off	8x 01 04 37 03 00 FF	
CAM_HLC	Parameter Set	8x 01 04 14 0p 0q FF	p:HLC Level (0:Off, 1:On) q:HLC mask level(0:Off, 1(low)~F(high)
CAM_SpotAE	On	8x 01 04 59 02 FF	Spot AE mode
	Off	8x 01 04 59 03 FF	
	Position	8x 01 04 29 0p 0q 0r 0s FF	pq:X(0-F), rs:Y(0-F)
CAM_Memory	Reset	8x 01 04 3F 00 0p FF	p:Memory Number(0-F)
	Set	8x 01 04 3F 01 0p FF	(See. Custom/Memory Preset Setting Items)

	Recall	8x 01 04 3F 02 0p FF	
CAM_Custom	Reset	8x 01 04 3F 00 7F FF	Starts up in this mode when the power is turned on (*The SET command must be sent one time to activate the custom preset. (* Inactive : When the power is turned on, it starts up in the settings before the power is turned off. (See. Custom/Memory Preset Setting Items)
	Set	8x 01 04 3F 01 7F FF	
	Recall	8x 01 04 3F 02 7F FF	
	Inactive	8x 01 04 3F 10 7F FF	
	Active	8x 01 04 3F 11 7F FF	

< Additional Command >

Command Set	Command	Command Packet	Comments
KT_KeyAct	Stop	8x 01 70 01 00 FF	
	Up	8x 01 70 01 21 FF	
	Down	8x 01 70 01 22 FF	
	Left	8x 01 70 01 23 FF	
	Right	8x 01 70 01 24 FF	
	Set	8x 01 70 01 26 FF	Enter Key
	Menu Off	8x 01 70 01 27 FF	Menu Off
	Factory Default	8x 01 70 01 0F FF	Initialize Camera Data
	Auto Zoom	8x 01 70 01 20 FF	Repeat TELE ~ WIDE. To stop, send the Auto Zoom command one more time
	Auto Zoom 1 time	8x 01 70 01 1F FF	
KT_DayNightMode	Auto	8x 01 70 04 00 FF	
	Day	8x 01 70 04 01 FF	
	Night	8x 01 70 04 02 FF	
	External-High	8x 01 70 04 03 FF	Night = Ext. input level is High
	External-Low	8x 01 70 04 04 FF	Night = Ext. input level is Low
KT_AutoICRdelay	Delay Time	8x 01 04 41 01 00 0p 0q FF	pq: sec (0~60sec)
KT_ExtICRthreshold (Ext.H or Ext.L mode)	Day->Night(EXT-H)	8x 01 70 05 10 0p 0q FF	pq: ICR OFF→ON Threshold Level (Day->Night)
	Night->Day(EXT-H)	8x 01 70 05 11 0p 0q FF	pq: ICR ON→OFF Threshold Level (Night->Day)
	Day->Night(EXT-L)	8x 01 70 05 20 0p 0q FF	pq: ICR OFF→ON Threshold Level (Day->Night)
	Night->Day(EXT-L)	8x 01 70 05 21 0p 0q FF	pq: ICR ON→OFF Threshold Level (Night->Day)
KT_PresetAFmode	Display Setting OSD	8x 01 70 02 00 FF	Display On the Preset AF setting OSD
	Cancel & Exit	8x 01 70 02 01 FF	Display Off the setting OSD and do not save
	Save & Exit	8x 01 70 02 02 FF	Display Off the setting OSD and save
	Test	8x 01 70 02 10 FF	Automatically repeats TELE/WIDE
	Preset AF range	8x 01 70 03 0p 0q FF	pq:00~FF, auto focusing range
KT_AgcAutoLimit	-	8x 01 70 34 pp FF	pp:AGC Max Limit (0x00~0x0F) See. GAIN LIMIT table)
KT_Sharpness	-	8x 01 70 53 0p FF	p:sharpness level (0x00~0x0E)
KT_AgcMode	-	8x 01 70 5C 0p FF	p=1(AGC On), 0(AGC Off)
KT_IrisCloseLimit	-	8x 01 70 2B pp FF	pp:Iris Close Limit, 0x00~0xA0 See. IRIS CLOSE LIMIT
KT_ZoomFocusPreset	Set	8x 01 70 3F 01 0p 0q 0r FF	pqr : preset Number (0x000~0x0FF)
	Recall	8x 01 70 3F 02 0p 0q 0r FF	pqr : preset Number (0x000~0x0FF)
	Clear	8x 01 70 3F 03 0p 0q 0r FF	pqr : preset Number (0x000~0x0FF)
	Clear All Preset	8x 01 70 3F 0F 00 00 00 FF	Clear all preset data
KT_HomePowerOn	On	8x 01 70 24 02 FF	Moving to x1 position after power on
	Off	8x 01 70 24 03 FF	After power on, move to final position before power off
KT_FontSize	Normal	8x 01 70 15 30 FF	Function OSD / Title font size
	Big	8x 01 70 15 31 FF	
KT_SyncTDN_AF		8x 01 70 06 0p 0q FF	AF is executed once when switching TDN p : Day→Night q : Night → Day 0:AF OFF, 1:AF ON
KT_FocusBoundary	Normal	8x 01 70 08 01 FF	Limit the movement range to inf ~ 1cm
	Release	8x 01 70 08 00 FF	Release the movement range of the lens
KT_AeManualAutoSet	On	8x 01 70 5D 01 FF	When switching from AE AUTO to MANUAL mode, the manual agc / iris / shutter level is set to the current brightness
	Off	8x 01 70 5D 00 FF	
KT_WbManualAutoSet	On	8x 01 70 26 01 FF	When switching from WB AUTO to MANUAL mode, the manual red/blue gain is set to the current color
	Off	8x 01 70 26 00 FF	
KT_Adj_Color	-	8x 01 70 25 pq 0r 0s FF	p : (0)direct setting (1)increase (2)decrease q : (1)BYGAIN- (2)BYGAIN+ (3)RYGAIN- (4)RYGAIN+ (5)BYHUE-(6)BYHUE+(7)RYHUE-(8)RYHUE+ (9)RED GAIN (A)GREEN GAIN (B)BLUE GAIN (F)Factory default rs : direct value (if p=0)
KT_AE_Manual_Preset	Save	8x 01 70 63 01 0q FF	q=0~7 : exposure preset number (* clear : if q=F : Clear All

	Recall	8x 01 70 63 02 0q FF	
	Clear	8x 01 70 63 03 0q FF	
KT_AE_OnePush	Start	81 01 70 61 00 FF	Wait 5 seconds
KT_WB_Manual_Preset	Save	8x 01 70 62 01 0q FF	q=0~7 : white balance preset number (* clear : if q=F : Clear All
	Recall	8x 01 70 62 02 0q FF	
	Clear	8x 01 70 62 03 0q FF	
KT_WB_OnePush	Start	81 01 70 60 00 FF	Wait 5 seconds
KT_DIS_Range	-	81 01 70 D0 0p FF	p : (1) 10% (2)20% (3)30%
KT_DIS_Filter	-	81 01 70 D1 0p FF	p : (1) Low (2) Mid (3) High
KT_DIS_AutoC	-	81 01 70 D2 0p FF	p : (1) Off (2) Half (3) Full
KT_SystemFactoryDef	Reset All Data	81 01 70 EF EF FF	Change all system data to the factory default state. Use of this command is very careful.
KT_Disable_SysReset	Disable	81 01 70 BE BE 02 FF	Prevent system initialization after FW upgrade. Use of this command is very careful.
	Enable	81 01 70 BE BE 03 FF	
KT_DaisyChain	OFF	88 40 00 FF	VISCA Daisy Chain Mode
	ON	88 40 01 FF	

## Inquiry Command List

Inquiry Command	Command Packet	Inquiry Packet	Comments
CAM_PowerInq	8x 09 04 00 FF	y0 50 02 FF	On
		y0 50 03 FF	Off (Standby)
CAM_ZoomPosInq	8x 09 04 47 FF	y0 50 0p 0q 0r 0s FF	pqrs: Zoom Position
CAM_DZoomModeInq	8x 09 04 06 FF	y0 50 02 FF	D-Zoom On
		y0 50 03 FF	D-Zoom Off
CAM_DZoomC/SModeInq	8x 09 04 36 FF	y0 50 00 FF	Combine Mode
		y0 50 01 FF	Separate Mode
CAM_DZoomPosInq	8x 09 04 46 FF	y0 50 00 00 0p 0q FF	pq: D-Zoom Position
CAM_FocusModeInq	8x 09 04 38 FF	y0 50 02 FF	Auto Focus
		y0 50 03 FF	Manual Focus
CAM_FocusPosInq	8x 09 04 48 FF	y0 50 0p 0q 0r 0s FF	pqrs: Focus Position
CAM_FocusNearLimitInq	8x 09 04 28 FF	y0 50 0p 0q 0r 0s FF	pqrs: Focus Near Limit Position
CAM_AFSensitivityInq	8x 09 04 58 FF	y0 50 02 FF	AF Sensitivity Normal
		y0 50 03 FF	AF Sensitivity Low
CAM_AFModeInq	8x 09 04 57 FF	y0 50 00 FF	Normal AF
		y0 50 01 FF	Interval AF
		y0 50 02 FF	Zoom Trigger AF
CAM_AFTimeSettingInq	8x 09 04 27 FF	y0 50 0p 0q 0r 0s FF	pq: Movement Time, rs: Interval
CAM_IRCorrectionInq	8x 09 04 11 FF	y0 50 00 FF	Standard
		y0 50 01 FF	IR Light
CAM_WBModeInq	8x 09 04 35 FF	y0 50 00 FF	Auto
		y0 50 01 FF	In Door
		y0 50 02 FF	Out Door
		y0 50 03 FF	One Push WB
		y0 50 04 FF	ATW
		y0 50 05 FF	Manual
CAM_RGainInq	8x 09 04 43 FF	y0 50 00 00 0p 0q FF	pq: R Gain
CAM_BGainInq	8x 09 04 44 FF	y0 50 00 00 0p 0q FF	pq: B Gain
CAM_AEModeInq	8x 09 04 39 FF	y0 50 00 FF	Full Auto
		y0 50 03 FF	Manual
		y0 50 0A FF	Shutter Priority
		y0 50 0B FF	Iris Priority
		y0 50 0D FF	Bright
CAM_SlowShutterModeInq	8x 09 04 5A FF	y0 50 02 FF	Auto
		y0 50 03 FF	Manual
CAM_ShutterPosInq	8x 09 04 4A FF	y0 50 00 00 0p 0q FF	pq: Shutter Position
CAM_IrisPosInq	8x 09 04 4B FF	y0 50 00 00 0p 0q FF	pq: Iris Position
CAM_GainPosInq	8x 09 04 4C FF	y0 50 00 00 0p 0q FF	pq: Gain Position
CAM_GainLimitInq	8x 09 04 2C FF	y0 50 0q FF	p: Gain Limit
CAM_BrightPosInq	8x 09 04 4D FF	y0 50 00 00 0p 0q FF	pq: Bright Position
CAM_ExpCompModeInq	8x 09 04 3E FF	y0 50 02 FF	On
		y0 50 03 FF	Off
CAM_ExpCompPosInq	8x 09 04 4E FF	y0 50 00 00 0p 0q FF	pq: ExpComp Position

CAM_BackLightModeInq	8x 09 04 33 FF	y0 50 02 FF	On
		y0 50 03 FF	Off
CAM_AE_ResponseInq	8x 09 04 5D FF	y0 50 pp FF	pp: 01 to 20 (hex)
CAM_WDModeInq	8x 09 04 3D FF	y0 50 02 FF	On Wide-D
		y0 50 03 FF	Off
CAM_WDParameterInq	8x 09 04 2D FF	y0 50 00 00 00 0s 00 00 00 00 FF	s: Blown-out highlight correction level
CAM_ApertureInq	8x 09 04 42 FF	y0 50 00 00 0p 0q FF	ppq: Aperture Gain
CAM_HRModeInq	8x 09 04 52 FF	y0 50 02 FF	On (Hi-Resolution)
		y0 50 03 FF	Off
CAM_NRModeInq	8x 09 04 53 FF	y0 50 0p FF	Noise Reduction p: 0 to 5
CAM_GammaInq	8x 09 04 5B FF	y0 50 0p FF	Gamma p: 0 to 6
CAM_HighSensitivityInq	8x 09 04 5E FF	y0 50 02 FF	On
		y0 50 03 FF	Off
CAM_LR_ReverseModeInq	8x 09 04 61 FF	y0 50 02 FF	On
		y0 50 03 FF	Off
CAM_FreezeModeInq	8x 09 04 62 FF	y0 50 02 FF	On
		y0 50 03 FF	Off
CAM_PictureEffectModeInq	8x 09 04 63 FF	y0 50 00 FF	Off
		y0 50 02 FF	Neg.Art
		y0 50 04 FF	B&W
CAM_PictureFlipModeInq	8x 09 04 66 FF	y0 50 02 FF	On
		y0 50 03 FF	Off
CAM_ICRModeInq	8x 09 04 01 FF	y0 50 02 FF	On
		y0 50 03 FF	Off
CAM_AutoICRModeInq	8x 09 04 51 FF	y0 50 02 FF	On
		y0 50 03 FF	Off
CAM_AutoICRThresholdInq	8x 09 04 21 FF	y0 50 00 00 0p 0q FF	ppq: ICR ON → OFF Threshold Level
CAM_AutoICRAAlarmReplyInq	8x 09 04 31 FF	y0 50 02 FF	On
		y0 50 03 FF	Off
CAM_MemSaveInq	8x 09 04 23 0X FF	y0 50 0p 0p 0q 0q FF	X: 00 to 07 (Address) ppqq: 0x0000 to 0xFFFF (Data)
CAM_DisplayModeInq	8x 09 04 15 FF (8x 09 06 06 FF)	y0 50 02 FF	On
		y0 50 03 FF	Off
CAM_MuteModeInq	8x 09 04 75 FF	y0 50 02 FF	On
		y0 50 03 FF	Off
CAM_PrivacyDisplayInq	8x 09 04 77 FF	y0 50 pp pp pp pp FF	pp pp pp pp: Mask Display (0: OFF, 1: ON)
CAM_PrivacyPanTiltInq	8x 09 04 79 FF	y0 50 0p 0p 0p 0q 0q 0q FF	ppp: Pan qq: Tilt
CAM_PrivacyPTZInq	8x 09 04 7B mm FF	y0 50 0p 0p 0p 0q 0q 0r 0r 0r 0r FF	mm: Mask Settings ppp: Pan qqq: Tilt rrr: Zoom
CAM_PrivacyMonitorInq	8x 09 04 6F FF	y0 50 pp pp pp pp FF	pp pp pp pp: Mask is displayed now.
CAM_IDInq	8x 09 04 22 FF	y0 50 0p 0q 0r 0s FF	pqrs: Camera ID
CAM_VersionInq	8x 09 00 02 FF	y0 50 00 78	mnpq: Model Code (04xx)
		mn pq rs tu vw FF	rstu: ROM version vw: Socket Number (=02) See. "Cam_VersionInq"
CAM_MDModeInq	8x 09 04 1B FF	y0 50 02 FF	On
		y0 50 03 FF	Off
CAM_MDFunctionInq	8x 09 04 1C FF	y0 50 0m 0n 0p 0q 0r 0s FF	m: Display mode n: Detection Frame Set (0 to F) pq: Threshold Level (0 to FF) rs: Interval Time set (0 to FF)
CAM_MDWindowInq	8x 09 04 1D 0m FF	y0 50 0p 0q 0r 0s FF	m: Select Detection Frame (0, 1, 2, 3) p: Start Horizontal Position (00 to 0B) q: Start Vertical Position (00 to 07) r: Stop Horizontal Position (01 to 0C) s: Stop Vertical Position (01 to 08)
CAM_ContinuousZoomPosReplyModeInq	8x 09 04 69 FF	y0 50 02 FF	On
		y0 50 03 FF	Off
CAM_ZoomPosReplyIntervalTimeInq	8x 09 04 6A FF	y0 50 00 00 0p 0p FF	pp: Interval Time
CAM_ContinuousFocusPosReplyModeInq	8x 09 04 16 FF	y0 50 02 FF	On
		y0 50 03 FF	Off
CAM_FocusPosReplyIntervalTimeInq	8x 09 04 1A FF	y0 50 00 00 0p 0p FF	pp: Interval Time
CAM_ExAutoICRThresholdIn	8x 09 04 1F 21 00 FF	y0 50 00 00 0p 0q FF	ppq : ICR ON→OFF threshold when Auto ICR

q			is on (Night → Day)
CAM_ExAutoICROnLevelInq	8x 09 04 1F 21 01 FF	y0 50 00 00 0p 0q FF	pq : ICR OFF→ON threshold when Auto ICR is on (Day → Night)
CAM_RegisterValueInq	8x 09 04 24 mm FF	y0 50 0p 0p FF	mm: Register No. (00 to 7F) pp: Register Value (00 to FF)
CAM_ColorGainInq	8x 09 04 49 FF	y0 50 00 00 00 0p FF	p: Color Gain setting 0h (60%) to Eh (200%)
CAM_ColorHueInq	8x 09 04 4F FF	y0 50 00 00 00 0p FF	p: Color Hue setting 0h (- 14 degrees) to Eh (+ 14 degrees)
CAM_StabilizerInq	8x 09 04 34 FF	y0 50 02 FF	Stabilizer(DIS) on
		y0 50 03 FF	Stabilizer(DIS) off
CAM_DefogInq	8x 09 04 37 FF	y0 50 02 0p FF	Defog On, p:defog level(1:low,2:middle,3:high)
		y0 50 03 00 FF	Defog Off
CAM_HLCInq	8x 09 04 14 FF	y0 50 0p 0q FF	p:HLC Level (0:Off, 1:On) q:HLC mask level(0:Off, 1(low)-F(high))
CAM_SpotAEModeInq	8x 09 04 59 FF	y0 50 02 FF	Spot AE on
		y0 50 03 FF	Spot AE Off
CAM_SpotAEPosInq	8x 09 04 29 FF	y0 50 0p 0q 0r 0s FF	pq:X(0-F), rs:Y(0-F)
CAM_MemoryInq	8x 09 04 3F FF	y0 50 pp FF	pp:memory number recalled last

< Additional Inquiry >

Inquiry Command	Command Packet	Inquiry Packet	Comments
KT_MenuOnOffInq	8x 09 70 01 FF	y0 50 02 FF	Menu on
		y0 50 03 FF	Menu off
KT_DayNightModeInq	8x 09 70 04 FF	y0 50 0p 0q FF	pq:day&night mode
KT_ExtICRthresholdInq	8x 09 70 05 10 FF	y0 50 0p 0q FF	pq:ext-H day->night threshold
		y0 50 0p 0q FF	pq:ext-H night->day threshold
		y0 50 0p 0q FF	pq:ext-L day->night threshold
		y0 50 0p 0q FF	pq:ext-L night->day threshold
KT_PresetAFRangeInq	8x 09 70 03 FF	y0 50 0p 0q FF	pq: preset AF range
KT_AgcAutoLimitInq	8x 09 70 34 FF	y0 50 pp FF	pp:AGC Max Limit (See. GAIN LIMIT table)
KT_SharpnessInq	8x 09 70 53 FF	y0 50 0p FF	p:sharpness level (0x00-0x0F)
KT_AgcModeInq	8x 09 70 5C FF	y0 50 0p FF	p:1(AGC On),0(AGC Off)
KT_IrisCloseLimitInq	8x 09 70 2B FF	y0 50 0p 0q FF	pq:Iris Close Limit, 0x00-0xA0
KT_ZoomFocusPresetInq	8x 09 703F 0n 0n 0n FF	y0 50 0v 0z 0z 0z 0f 0f 0f FF	nnn:preset number(0x000-0x0FF) v : 1(saved), 0(empty) zzzz : zoom position ffff : focus position
KT_HomePowerOnInq	8x 09 70 24 FF	y0 50 0p FF	p:Home Position Mode, 2(ON)/3(OFF)
KT_CustomPresetInq	8x 09 70 3E FF	y0 50 0p FF	p: 1(custom preset activate) 0(custom preset inactive)
KT_FontSizeInq	8x 09 70 15 FF	y0 50 0p FF	p: 0(Normal Size) / 1(Big Size)
KT_SyncTDN_AFinq	8x 09 70 06 FF	y0 50 0p 0q FF	p : Day→Night q : Night → Day 0:AF OFF, 1:AF ON
KT_FocusBoundaryInq	8x 09 70 08 FF	y0 50 0p FF	P: (0)Normal, (1)Release
KT_AeManualAutoSetInq	8x 09 70 5D FF	y0 50 0p FF	P: (0)Off, (1)On
KT_WbManualAutoSetInq	8x 09 70 26 FF	y0 50 0p FF	P: (0)Off, (1)On
KT_Adj_ColorInq	8x 09 70 25 0p FF	y0 50 0r 0s FF	p : (1)BYGAIN- (2)BYGAIN+ (3)RYGAIN- (4)RYGAIN+ (5)BYHUE-(6)BYHUE+ (7)RYHUE-(8)RYHUE+ (9)RED GAIN (A)GREEN GAIN (B)BLUE GAIN rs : value
KT_AE_Manual_PresetInq	8x 09 70 63 0q FF	y0 50 0r FF	q=0-7 : exposure preset number r = 0(empty) / 1(saved)
KT_WB_Manual_PresetInq	8x 09 70 62 0q FF	y0 50 0r FF	q=0-7 : white balance preset number r = 0(empty) / 1(saved)
KT_AE_OnePushInq	81 09 70 61 FF	y0 50 0r FF	r=0(finished) / 1(action)
KT_WB_OnePushInq	81 09 70 60 FF	y0 50 0r FF	r=0(finished) / 1(action)
KT_DIS_RangeInq	81 09 70 D0 FF	y0 50 0r FF	r=1(10%) / 2(20%) / 3(30%)
KT_DIS_FilterInq	81 09 70 D1 FF	y0 50 0r FF	r=1(low)/2(mid)/3(high)
KT_DIS_AutoCInq	81 09 70 D2 FF	y0 50 0r FF	r=1(off)/2(half)/3(full)
KT_Disable_SysResetInq	81 09 70 BE FF	y0 50 0r FF	r=2(disable)/3(enable)

Lens Control System Inquiry Commands ..... Command Packet 8x097E7E00FF

Byte	Bit	Comments
0	7	Destination Address
	6	
	5	
	4	
	3	Source Address
	2	
	1	
	0	
1	7	0 Completion Message
	6	1
	5	0
	4	1
	3	0
	2	0
	1	0
	0	0
2	7	0
	6	0
	5	0
	4	0
	3	Zoom Position (HH)
	2	
	1	
	0	
3	7	0
	6	0
	5	0
	4	0
	3	Zoom Position (HL)
	2	
	1	
	0	
4	7	0
	6	0
	5	0
	4	0
	3	Zoom Position (LH)
	2	
	1	
	0	
5	7	0
	6	0
	5	0
	4	0
	3	Zoom Position (LL)
	2	
	1	
	0	

Byte	Bit	Comments
6	7	0
	6	0
	5	0
	4	0
	3	Focus Near Limit (H)
	2	
	1	
	0	
7	7	0
	6	0
	5	0
	4	0
	3	Focus Near Limit (L)
	2	
	1	
	0	
8	7	0
	6	0
	5	0
	4	0
	3	Focus Position (HH)
	2	
	1	
	0	
9	7	0
	6	0
	5	0
	4	0
	3	Focus Position (HL)
	2	
	1	
	0	
10	7	0
	6	0
	5	0
	4	0
	3	Focus Position (LH)
	2	
	1	
	0	
11	7	0
	6	0
	5	0
	4	0
	3	Focus Position (LL)
	2	
	1	
	0	

Byte	Bit	Comment
12	7	0
	6	0
	5	0
	4	0
	3	0
	2	0
	1	0
	0	0
13	7	0
	6	0
	5	DZoomMode 0: Combine 1: Separate
	4	0: Normal 1: Interval
	3	2: Zoom Trigger
	2	AF Sensitivity 0: Slow 1: Normal
	1	Digital Zoom 1: On 0: Off
	0	Focus Mode 0: Manual 1: Auto
14	7	0
	6	0
	5	0
	4	0
	3	Low Contrast Detection 1: Yes 0: No
	2	Camera Memory Recall 1: Executing 0:
	1	Focus Command 1: Executing 0: Stopped
	0	Zoom Command 1: Executing 0: Stopped
15	7	1 Terminator (FFh)
	6	1
	5	1
	4	1
	3	1
	2	1
	1	1
	0	1

Camera Control System Inquiry Commands ..... Command Packet 8x097E7E01FF

Byte	Bit	Comments
0	7	Destination Address
	6	
	5	
	4	
	3	Source Address
	2	
	1	
	0	
1	7	0 Completion Message
	6	1
	5	0
	4	1
	3	0
	2	0
	1	0
	0	0
2	7	0
	6	0
	5	0
	4	0
	3	R Gain (H)
	2	
	1	
	0	
3	7	0
	6	0
	5	0
	4	0
	3	R Gain (L)
	2	
	1	
	0	
4	7	0
	6	0
	5	0
	4	0
	3	B Gain (H)
	2	
	1	
	0	
5	7	0
	6	0
	5	0
	4	0
	3	B Gain (L)
	2	
	1	
	0	

Byte	Bit	Comments
6	7	0
	6	0
	5	0
	4	0
	3	WB Mode
	2	
	1	
	0	
7	7	0
	6	0
	5	0
	4	0
	3	Aperture Gain
	2	
	1	
	0	
8	7	0
	6	0
	5	0
	4	Exposure Mode
	3	
	2	
	1	
	9	7
6		0
5		High-Resolution 1: On 0: Off
4		Wide-D (1: Other than Off, 0: Off)
3		0
2		Back Light 1: On 0: Off
1		Exposure Comp. 1: On 0: Off
0		Slow Shutter 1: Auto 0:
10	7	0
	6	0
	5	0
	4	Shutter Position
	3	
	2	
	1	
	11	7
6		0
5		0
4		Iris Position
3		
2		
1		
0		0

Byte	Bit	Comments
12	7	0
	6	0
	5	0
	4	0
	3	Gain Position
	2	
	1	
	0	
13	7	0
	6	0
	5	0
	4	Bright Position
	3	
	2	
	1	
	14	7
6		0
5		0
4		0
3		Exposure Comp. Position
2		
1		
0		
15	7	1 Terminator (FFh)
	6	1
	5	1
	4	1
	3	1
	2	1
	1	1
	0	1



Other Inquiry Commands ..... Command Packet 8x097E7E02FF

Byte	Bit	Comments
0	7	Destination Address
	6	
	5	
	4	
	3	Source Address
	2	
	1	
	0	
1	7	0 Completion Message
	6	1
	5	0
	4	1
	3	0
	2	0
	1	0
	0	0
2	7	0
	6	0
	5	0
	4	0
	3	Auto ICR Alarm (1: On, 0:
	2	Auto ICR 1: On 0: Off
	1	0
0	Power 1: On 0: Off	
3	7	0
	6	0
	5	0
	4	ICR 1: On 0: Off
	3	Freeze 1: On 0: Off
	2	LR Reverse 1: On 0: Off
	1	0
0	0	
4	7	0
	6	0
	5	Privacy Zone 1: On 0: Off
	4	Mute 1: On 0: Off
	3	Title Display 1: On 0: Off
	2	Display 1: On 0: Off
	1	0
	0	0
5	7	0
	6	0
	5	0
	4	0
	3	Picture Effect Mode
	2	
1		
0		

Byte	Bit	Comments
6	7	0
	6	0
	5	0
	4	0
	3	0
	2	0
	1	0
	0	0
7	7	0
	6	0
	5	0
	4	0
	3	0
	2	0
	1	0
	0	0
8	7	0
	6	0
	5	0
	4	0
	3	Camera ID (HH)
	2	
	1	
	0	
9	7	0
	6	0
	5	0
	4	0
	3	Camera ID (HL)
	2	
	1	
	0	
10	7	0
	6	0
	5	0
	4	0
	3	Camera ID (LH)
	2	
	1	
	0	
11	7	0
	6	0
	5	0
	4	0
	3	Camera ID (LL)
	2	
	1	
	0	

Byte	Bit	Comments
12	7	0
	6	0
	5	0
	4	Memory 1: Provided 0: Not provided
	3	0
	2	ICR 1: Provided 0: Not provided
	1	Stabilizer 1:provided, 0: not provided
	0	1: 1/50, 1/25 0: 1/60, 1/30
13	7	0
	6	0
	5	0
	4	0
	3	Day&Night Mode 0:auto 1:day 2:night 3:Ext-H, 4:Ext-L
	2	
1		
0		
14	7	0
	6	0
	5	0
	4	0
	3	0
	2	0
	1	0
0	0	
15	7	1 Terminator (FFh)
	6	1
	5	1
	4	1
	3	1
	2	1
	1	1
	0	1

Enlargement Function1 Query Command..... Command Packet 8x 09 7E 7E 03 FF

Byte	Bit	Comments
0	7	Destination Address
	6	
	5	
	4	
	3	Source Address
	2	
	1	
	0	
1	7	0 Completion Message
	6	1
	5	0
	4	1
	3	0
	2	0
	1	0
	0	0
2	7	0
	6	0
	5	0
	4	0
	3	Digital Zoom Position (H)
2		
3	7	0
	6	0
	5	0
	4	0
	3	Digital Zoom Position (L)
2		
4	7	0
	6	0
	5	0
	4	0
	3	AF Activation Time (H)
2		
1		
5	7	0
	6	0
	5	0
	4	0
	3	AF Activation Time (L)
2		
1		
0		

Byte	Bit	Comments
6	7	0
	6	0
	5	0
	4	0
	3	AF Interval Time (H)
2		
1		
7	7	0
	6	0
	5	0
	4	0
	3	AF Interval Time (L)
2		
1		
8	7	0
	6	0
	5	0
	4	0
	3	0
2		
9	7	0
	6	0
	5	0
	4	0
	3	0
2		
1		
10	7	0
	6	0
	5	0
	4	0
	3	0
2	MD (1: On, 0: Off)	
1	Reserved	
0	Picture flip (1: On, 0: Off)	

Byte	Bit	Comments
11	7	0
	6	Color Gain (0h (60%) to Eh (200%))
	5	
	4	
	3	Advanced Privacy (1: Provided, 0: Not provided)
2		
12	1	Alarm (1: Provided, 0: Not provided)
	0	Picture flip (1: Provided, 0: Not provided)
	7	0
13	6	0
	5	0
	4	0
	3	
	2	Gamma
1		
14	0	High Sensitivity mode (1: ON, 0: OFF)
	7	
	6	NR Level
	5	
	4	
15	3	Gain Limit
	2	
	1	
	0	
	7	
15	6	1
	5	1
	4	1
	3	1
	2	1
	1	1
	0	1

Enlargement Function2 Query Command..... Command Packet 8x 09 7E 7E 04 FF

Byte	Bit	Comm
0	7	Destination Address
	6	
	5	
	4	
	3	Source Address
	2	
	1	
0		
1	7	0 Completion Message
	6	1
	5	0
	4	1
	3	0
	2	0
	1	0
	0	0
2	7	0
	6	0
	5	0
	4	0
	3	0
	2	WideD mode (0: OFF, 1: ON)
1		
0		
3	7	0
	6	0
	5	0
	4	0
	3	0
	2	
	1	0
	0	
4	7	0
	6	0
	5	0
	4	0
	3	0
	2	
	1	WideD blown-out highlight
	0	correction level 0: L 1: M 2: H
5	7	0
	6	0
	5	0
	4	0
	3	0
	2	
	1	
	0	

Byte	Bit	Comments
6	7	0
	6	0
	5	0
	4	0
	3	0
	2	
	1	
	0	
7	7	0
	6	0
	5	0
	4	0
	3	0
	2	0
	1	0
	0	Defog Mode(1:on,0:off)
8	7	0
	6	0
	5	0
	4	0
	3	0
	2	0
	1	0
	0	0
9	7	0
	6	0
	5	0
	4	0
	3	0
	2	0
	1	0
	0	0
10	7	0
	6	0
	5	0
	4	0
	3	0
	2	0
	1	0
	0	0

Byte	Bit	Comments
11	7	0
	6	0
	5	0
	4	0
	3	0
	2	0
	1	0
	0	0
12	7	0
	6	0
	5	0
	4	0
	3	0
	2	0
	1	0
	0	0
13	7	0
	6	0
	5	0
	4	0
	3	0
	2	0
	1	0
	0	0
14	7	0
	6	0
	5	0
	4	0
	3	0
	2	0
	1	0
	0	0
15	7	1 Terminator (FFh)
	6	1
	5	1
	4	1
	3	1
	2	1
	1	1
	0	1

Enlargement Function3 Query Command..... Command Packet 8x 09 7E 7E 05 FF

Byte	Bit	Comments	
0	7	Destination Address	
	6		
	5		
	4		
	3		Source Address
	2		
1			
0			
1	7	0 Completion Message	
	6	1	
	5	0	
	4	1	
	3	0	
	2	0	
	1	0	
	0	0	
2	7	0	
	6	0	
	5	0	
	4	0	
	3	0	
2			
1			
3	7	0	
	6	Reserved	
	5		
	4		
	3		
	2		
1			
4	7	0	
	6	Reserved	
	5		
	4		
	3		
	2		
	1		
	0		
5	7		0
	6	Reserved	
	5		
	4		
	3		
	2		
1			
0			

Byte	Bit	Comment
6	7	0
	6	Reserved
	5	
	4	
	3	
	2	
1		
0		
7	7	0
	6	Reserved
	5	
	4	
	3	
	2	
	1	
	0	
8	7	
	6	Reserved
	5	
	4	
	3	
	2	
1		
0		
9	7	0
	6	Reserved
	5	
	4	
	3	
	2	
1		
0		
10	7	0
	6	Reserved
	5	
	4	
	3	
	2	
	1	
	0	

Byte	Bit	Comments
11	7	0
	6	Reserved
	5	
	4	
	3	
	2	
1		
0		
12	7	0
	6	Reserved
	5	
	4	
	3	
	2	
	1	
	0	
13	7	
	6	Reserved
	5	
	4	
	3	
	2	
1		
0		
14	7	0
	6	Reserved
	5	
	4	
	3	
	2	
1		
0		
15	7	1 Terminator (FFh)
	6	1
	5	1
	4	1
	3	1
	2	1
	1	1
	0	1

## Command Setting Values

### SHUTTER SPEED

Index	60/30 mode	50/25 mode
15	1/10000	1/10000
14	1/6000	1/6000
13	1/4000	1/3500
12	1/3000	1/2500
11	1/2000	1/1750
10	1/1500	1/1250
0F	1/1000	1/1000
0E	1/725	1/600
0D	1/500	1/425
0C	1/350	1/300
0B	1/250	1/215
0A	1/180	1/150
09	1/125	1/120
08	1/100	1/100
07	1/90	1/75
06	1/60	1/50
05	1/30	1/25
04	1/15	1/12
03	1/8	1/6
02	1/4	1/3
01	1/2	1/2
00	1/1	1/1

### IRIS

Index	Iris
11	F1.6
10	F2
0F	F2.4
0E	F2.8
0D	F3.4
0C	F3.8
0B	F4.2
0A	F4.8
09	F5.4
08	F6
07	F6.8
06	F8
05	F9.6
04	F11
03	F14
02	F16
01	F19
00	CLOSE

### GAIN LIMIT & GAIN POSITION

Index	Gain
0F	+58dB
0E	+52dB
0D	+48dB
0C	+44dB
0B	+40dB
0A	+36dB
09	+32dB
08	+28dB
07	+24dB
06	+20dB
05	+16dB
04	+12dB
03	+8dB
02	+4dB
01	+0dB (OFF)
00	-3dB

### EXPOSURE COMPENSTAION(bright)

Index	Iris	Gain
0E	+7	+10.5 dB
0D	+6	+9 dB
0C	+5	+7.5 dB
0B	+4	+6 dB
0A	+3	+4.5 dB
09	+2	+3 dB
08	+1	+1.5 dB
07	0	0 dB
06	-1	-1.5 dB
05	-2	-3 dB
04	-3	-4.5 dB
03	-4	-6 dB
02	-5	-7.5 dB
01	-6	-9 dB
00	-7	-10.5 dB

### Aperture (=sharpness)

Index	Level
0F	Sharp
...	
00	Dull

Red/Blue Manual Gain  
0x00 ~ 0xFF

### AE BRIGHT MODE LEVEL

Index	Iris	Gain
1F	F1.6	+58dB
1E	F1.6	+52dB
1D	F1.6	+48dB
1C	F1.6	+44dB
1B	F1.6	+40dB
1A	F1.6	+36dB
19	F1.6	+32dB
18	F1.6	+28dB
17	F1.6	+24dB
16	F1.6	+20dB
15	F1.6	+16dB
14	F1.6	+12dB
13	F1.6	+8dB
12	F1.6	+4dB
11	F1.6	0 dB
10	F2	0 dB
0F	F2.4	0 dB
0E	F2.8	0 dB
0D	F3.4	0 dB
0C	F3.8	0 dB
0B	F4.2	0 dB
0A	F4.8	0 dB
09	F5.4	0 dB
08	F6	0 dB
07	F6.8	0 dB
06	F8	0 dB
05~01	F9.6~F11	0 dB
00	CLOSE	0 dB

### IRIS CLOSE LIMIT

Index	Open Level
A0	More Open
...	
60	default
...	
10	More Close

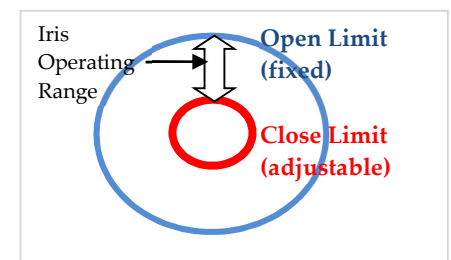

### Lens Control

Zoom Position	0000 ~ 4000 ~ 7AC0 Wide end      Optical      Digital Tele end      Tele end																	
Focus Position	1000 ~ F000 Far end      Near end																	
Focus Near Limit	<table border="1"> <tr> <td>1000 // inf</td> <td rowspan="14">The Lower 1 byte is fixed to 00  (* ) As the distance on the left will differ due to temperature or any other conditions.</td> </tr> <tr><td>1200 //500m</td></tr> <tr><td>1400 //200m</td></tr> <tr><td>1600 //100m</td></tr> <tr><td>1700 //60m</td></tr> <tr><td>2000 // 30m</td></tr> <tr><td>2400 //20m</td></tr> <tr><td>3000 // 10m</td></tr> <tr><td>5000 // 5m</td></tr> <tr><td>7000 // 3m</td></tr> <tr><td>8000 //2.5m</td></tr> <tr><td>9000 // 2m</td></tr> <tr><td>A000 // 1.5m</td></tr> <tr><td>C000 // 1m</td></tr> <tr><td>D000 // 50cm</td></tr> <tr><td>F000 // 10cm</td></tr> </table>	1000 // inf	The Lower 1 byte is fixed to 00  (* ) As the distance on the left will differ due to temperature or any other conditions.	1200 //500m	1400 //200m	1600 //100m	1700 //60m	2000 // 30m	2400 //20m	3000 // 10m	5000 // 5m	7000 // 3m	8000 //2.5m	9000 // 2m	A000 // 1.5m	C000 // 1m	D000 // 50cm	F000 // 10cm
1000 // inf	The Lower 1 byte is fixed to 00  (* ) As the distance on the left will differ due to temperature or any other conditions.																	
1200 //500m																		
1400 //200m																		
1600 //100m																		
1700 //60m																		
2000 // 30m																		
2400 //20m																		
3000 // 10m																		
5000 // 5m																		
7000 // 3m																		
8000 //2.5m																		
9000 // 2m																		
A000 // 1.5m																		
C000 // 1m																		
D000 // 50cm																		
F000 // 10cm																		

### Optical Zoom Position

Zoom Ratio	Optical Zoom Position
X1	0000
X2	16A1
X3	2063
X4	2628
X5	2A1D
X6	2D13
X7	2F6D
X8	3161
X9	330D
X10	3486
X11	35D7
X12	3709
X13	3820
X14	3920
X15	3A0A
X16	3ADD
X17	3B9C
X18	3C46
X19	3CDC
X20	3D60
X21	3DD4
X22	3E39
X23	3E90
X24	3EDC
X25	3F1E
X26	3F57
X27	3F8A
X28	3FB6
X29	3FDC
X30	4000

### Digital Zoom Position

Digital Zoom Ratio	Combine Mode	Separate Mode
X1	4000	00
X2	6000	80
X3	6A80	AA
X4	7000	C0
X5	7300	CC
X6	7540	D5
X7	76C0	DB
X8	7800	E0
X9	78C0	E3
X10	7980	E6
X11	7A00	E8
X12	7AC0	EB

### Tele/Wide Limit Setting

Value	Wide Limit		Tele Limit	
	Zoom	Ratio	Zoom	Ratio
00	0000	1	4000	30
10	00C4	1.02	3F3B	25.5
20	0188	1.04	3E77	22.7
30	024C	1.06	3DB3	20.7
40	0310	1.08	3CEF	19.1
50	03D4	1.11	3C2B	17.8
60	0498	1.13	3B67	16.7
70	055C	1.15	3AA3	15.7
80	0620	1.18	39DF	14.8
90	06E4	1.2	391B	14
A0	07A8	1.23	3857	13.2
B0	086C	1.26	3793	12.5
C0	0930	1.28	36CF	11.8
D0	09F4	1.31	360B	11.2
E0	0AB8	1.34	3547	10.6
F0	0B7C	1.38	3483	10
FF	0C33	1.41	33CC	9.5

### GAMMA POSITION

Index	Gamma
0	0.45
1	0.50
2	0.55
3	0.60
4	0.65
5	0.70
6	0.75

## Title Setting

Line number	00 to 14h	
H-position	00 to 28h	
Blink	00: Dose not blink	
	01: Blinks	
Color	00	White
	01	Yellow
	02	Violet
	03	Red
	04~06	White

00	01	02	03	04	05	06	07
A	B	C	D	E	F	G	H
08	09	0a	0b	0c	0d	0e	0f
I	J	K	L	M	N	O	P
10	11	12	13	14	15	16	17
Q	R	S	T	U	V	W	X
18	19	1a	1b	1c	1d	1e	1f
Y	Z	&		?	!	1	2
20	21	22	23	24	25	26	27
3	4	5	6	7	8	9	0
28	29	2a	2b	2c	2d	2e	2f
À	È	Ì	Ò	Û	Á	É	Í
30	31	32	33	34	35	36	37
Ó	Ú	Â	Ê	Ô	Æ		Ã
38	39	3a	3b	3c	3d	3e	3f
Ö	Ñ	Ç	ß	Ä	Ï	Ö	Ü
40	41	42	43	44	45	46	47
À	\$		¥		£	ı	i
48	49	4a	4b	4c	4d	4e	4f
ø	“	:	’	.	,	/	-
50							
→							

## Custom/Memory Preset Setting Items

Item	Custom Preset	Memory Preset
Zoom Position	O	O
Digital Zoom On/Off	O	O
Digital Zoom Position	O	X
Zoom Start Position	O	X
Zoom Stop Position	O	X
Zoom Speed	O	X
AF Home Position	O	X
AF Limited Range	O	X
Focus Position	O	O
Focus Mode	O	O
Near Limit Setting	O	X
AF Sensitivity	O	X
AF Mode	O	O
AF Run Time	O	X
AF Interval Time	O	X
WB Mode	O	O

WB Data(Rgain,Bgain)	O	O
COLOR Gain	O	X
AE Mode	O	O
AE Response	O	X
AE Slow Shutter	O	O
Shutter Position	O	O
Iris Position	O	O
Gain Position	O	O
Gain Limit	O	O
Bright Position	O	O
Exposure Compensation Mode	O	O
Exposure Compensation Amount	O	O
Flickerless	O	X
Aperture Level	O	O
Gamma	O	X
High Resolution	O	X
LR Reverse	O	X
Picture Flip	O	X
Freeze	O	X
Picture Effect	O	X
D-WDR	O	X
Defog	O	O
Defog Level	O	X
3DNR Mode	O	O
3DNR Level	O	X
2DNR Mode	O	X
2DNR Weight	O	X
Digital Image Stabilizer On/Off	O	X
Digital Image Stabilizer Setting	O	X
BackLight On/Off	O	O
BLC Setting	O	X
WDR On/Off	O	O
HLC On/off	O	X
HLC Setting	O	X
ICR On/Off	O	O
Auto ICR On/Off	O	O
Auto ICR Threshlod Level	O	X
Day&Night Dwell Time	O	X
Day->Night AGC level	O	X
Night->Day AGC level	O	X
Day->Night EXT-H level	O	X
Night -> Day EXT-H level	O	X
Day->Night EXT-L level	O	X
Night -> Day EXT-L level	O	X
Privacy Mask On/Off	O	X
Privacy Mask Display	O	X
Privacy Mask Setting	O	X
Motion On/Off	O	X
Motion Display	O	X
Motion Setting	O	X
Title Display On/Off	O	X
Title Setting	O	X
Display On/Off	O	X
ETC	X	X

## Register Setting

CAM_RegisterValue	8x 01 04 24 mm 0p 0p FF	mm: Register No. (=00-7F) pp: Register Value (=00-7F)
-------------------	----------------------------	--

command	Register (mm)	Value (pp)	contents
VISCA Baud Rate	00	00 (Default)	9600 bps
		01	19200 bps
		02	38400 bps
		03	115200bps
		04	57600 bps
		05	2400 bps
		06	4800 bps
Monitoring Mode	72	01	1080i/60
		02	1080i/60
		04	1080i/50
		06	1080p/30
		07	1080p/30
		08	1080p/25
		09	720p/60
		0A	720p/60
		0C	720p/50
		0E	720p/30
		0F	720p/30
		11	720p/25
		13	1080p/60
		14	1080p/50
		15	1080p/60
LVDS mode	74	00 (Default)	Single output
		01	Dual output
Zoom Limit	50	00~FF (default:00)	Wide Limit
	51	00~FF (default:00)	Tele Limit
E-Zoom Max	52	00-FF (Default:EB)	Max. digital zoom ratio = $256 \div (256 - \text{Value})$
FocusOffset @DomeCover	55	00-FF (Default:00)	00: None FF: Max.
Auto Slow shutter limit	56	01 (default)	1/30
		02	1/15
		03	1/8
		04	1/4
		05	1/2
		06	1/1
Enlargement Mode	5F	00~FF (default:00)	Bit3:Auto ICR OFF→ON setting enable ON/OFF (1:ON, 0:OFF)

Language	60	00-06	00:English 01:Russian 02:Spanish 03:Chinese 04:German 05:Franch 06:Portuguese 07:Japanes
CVBS scale	7C	00 01	4:3 16:9
EX-SDI V1.0	7E	00 01	OFF ON
DVR-Select (=color type)	4D	00~XX	pp : DVR See. DVR select

### \* DVR Select \*

Z7830H-LA (AHD)		Z7830H-LT (TVI)	
pp	DVR TYPE	pp	DVR TYPE
00	STANDARD	00	STANDARD
01	CVBS	01	CVBS
02	USER	02	USER
03	FOCUS	03	HIKVISION-B
04	RAYSHARP	04	HIKVISION-A
05	TAGATEC	05	WEBGATE
06	TECHWIN	06	RAYSHARP
07	3R		
08	CHN		



Command	Output : PELCO-D	Description
Zoom +	FF 01 00 20 00 00 CS	
Zoom -	FF 01 00 40 00 00 CS	
Focus +	FF 01 01 00 00 00 CS	
Focus -	FF 01 00 80 00 00 CS	
Iris +	FF 01 02 00 00 00 CS	It is used for Menu
Iris -	FF 01 04 00 00 00 CS	
Stop	FF 01 00 00 00 00 CS	
Go To Preset	FF 01 00 07 00 zz CS	zz : preset no (00-FF) total 256 zoom/focus position presets. Reserved presets : zz = 21, 5F, 60,62
Set Preset	FF 01 00 03 00 zz CS	
Clear Preset	FF 01 00 05 00 zz CS	
Flip(180 rotate)	FF 01 00 07 00 21 CS	
Menu or SET	FF 01 00 07 00 5F CS	Menu command(Go to preset + 95)
Menu or SET	FF 01 00 07 00 60 CS	Menu command(Go to preset + 96)
Menu or SET	FF 01 00 03 00 62 CS	Menu command(Set preset + 98)
Zoom speed	FF 01 00 25 00 zz CS	zz = 00(slow)~03 (fast), default:02
Reset camera to default	FF 01 00 29 00 00 CS	Initialize camera settings
Auto focus auto/on/off	FF 01 00 2B 00 zz CS	zz = 00(auto),01(one push AF),02(one push mode), 03(manual), 04(one shot-limit)
Backlight on/off	FF 01 00 31 00 zz CS	zz = 01(on),02(off)
Auto white balance on/off	FF 01 00 33 00 zz CS	zz = 01(Auto WB mode),02(manual WB mode)
Set Shutter speed	FF 01 00 37 zz zz CS	zzzz : shutter speed (see. Shutter speed table)

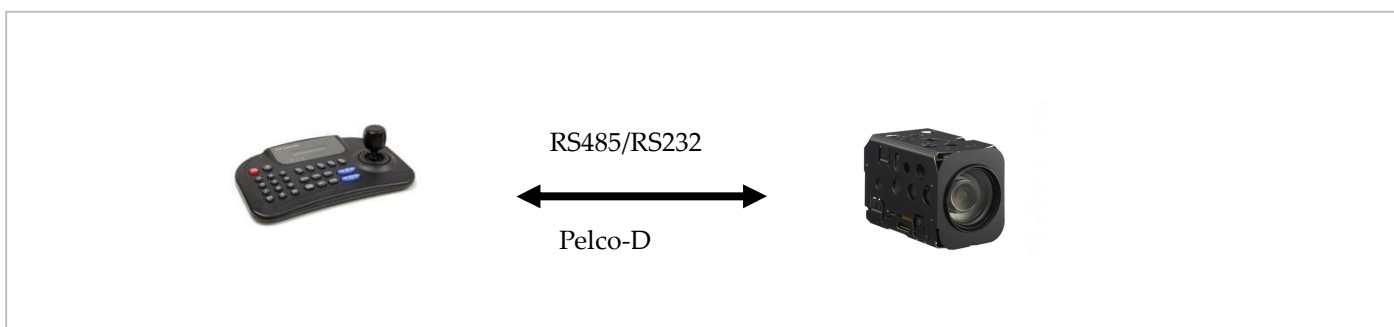

## Supported DVRs

Since the color representation differs depending on the DVR, you have to select the type of DVR to use.

Video Output	HD-AHD	HD-TVI	HD-SDI	EX-SDI(V1.0)
Standard Device	STANDARD (*)	STANDARD(*)	STANDARD(*)	STANDARD(*)
	CVBS(*)	CVBS(*)	CVBS(*)	CVBS(*)
DVR manufacturer	RAYSHARP	HIK VISION (A/B)		
	TECHWIN	WEBGATE		
	FOCUS	RAYSHARP		
	3R			
	TAGATEC			

(\*) STANDRAD : Standard Color

(\*) CVBS : If you connect directly to a CVBS monitor, select "CVBS".

(\*)Alternatively, you can change the color directly in the menu.